

HiPerFAST™ IGBT with Fast Diode

IXGH 32N90B2D1
IXGT 32N90B2D1

B2-Class High Speed IGBTs with Ultrafast Diode

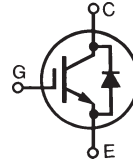

$$\begin{aligned} V_{CES} &= 900 \text{ V} \\ I_{C25} &= 64 \text{ A} \\ V_{CE(sat)} &= 2.7 \text{ V} \\ t_{fi typ} &= 150 \text{ ns} \end{aligned}$$

Symbol	Test Conditions	Maximum Ratings	
V_{CES}	$T_J = 25^\circ\text{C}$ to 150°C	900	V
V_{CGR}	$T_J = 25^\circ\text{C}$ to 150°C ; $R_{GE} = 1 \text{ MW}$	900	V
V_{GES}	Continuous	± 20	V
V_{GEM}	Transient	± 30	V
I_{C25}	$T_C = 25^\circ\text{C}$	64	A
I_{C110}	$T_C = 110^\circ\text{C}$	32	A
I_{CM}	$T_C = 25^\circ\text{C}$, 1 ms	200	A
SSOA (RBSOA)	$V_{GE} = 15 \text{ V}$, $T_{VJ} = 125^\circ\text{C}$, $R_G = 10 \Omega$ Clamped inductive load: $V_{CL} < 600\text{V}$	$I_{CM} = 64$	A
P_C	$T_C = 25^\circ\text{C}$	300	W
T_J		-55 ... +150	$^\circ\text{C}$
T_{JM}		150	$^\circ\text{C}$
T_{stg}		-55 ... +150	$^\circ\text{C}$
Maximum lead temperature for soldering 1.6 mm (0.062 in.) from case for 10 s		300	$^\circ\text{C}$
M_d	Mounting torque (TO-247)	1.13/10Nm/lb.in.	
Weight		TO-247	6 g
		TO-268	4 g

TO-247 (IXGH)

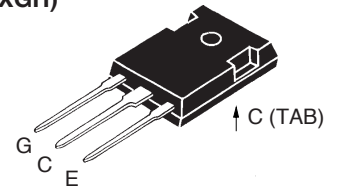

TO-268 (IXGT)

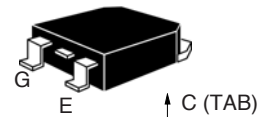

G = Gate C = Collector
E = Emitter TAB = Collector

Features

- High frequency IGBT
- High current handling capability
- MOS Gate turn-on
- drive simplicity

Applications

- PFC circuits
- Uninterruptible power supplies (UPS)
- Switched-mode and resonant-mode power supplies
- AC motor speed control
- DC servo and robot drives
- DC choppers

Advantages

- High power density
- Very fast switching speeds for high frequency applications

Symbol	Test Conditions	Characteristic Values ($T_J = 25^\circ\text{C}$ unless otherwise specified)		
		min.	typ.	max.
$V_{GE(th)}$	$I_C = 250 \text{ mA}$, $V_{CE} = V_{GE}$	3.0		5.0 V
I_{CES}	$V_{CE} = V_{CES}$ $V_{GE} = 0 \text{ V}$ $T_J = 150^\circ\text{C}$			300 μA 1.5 mA
I_{GES}	$V_{CE} = 0 \text{ V}$, $V_{GE} = \pm 20 \text{ V}$			$\pm 100 \text{ nA}$
$V_{CE(sat)}$	$I_C = I_{C110}$, $V_{GE} = 15 \text{ V}$ $T_J = 125^\circ\text{C}$	2.2 2.1	2.7	V V

Symbol	Test Conditions	Characteristic Values			
		(T _J = 25°C unless otherwise specified)			
		Min.	Typ.	Max.	
g_{fs}	I _C = I _{C110} , V _{CE} = 10 V Pulse test, t < 300 μs, duty cycle < 2 %	18	28	S	
C_{ies}	V _{CE} = 25 V, V _{GE} = 0 V, f = 1 MHz		1790	pF	
C_{oes}			146	pF	
C_{res}			49	pF	
Q_g	I _C = I _{C110} , V _{GE} = 15 V, V _{CE} = 0.5 V _{CES}		89	nC	
Q_{ge}			15	nC	
Q_{gc}			34	nC	
t_{d(on)}	Inductive load, T_J = 25°C I _C = I _{C110} , V _{GE} = 15 V V _{CE} = 720 V, R _G = R _{off} = 5 Ω		20	ns	
t_{ri}			22	ns	
t_{d(off)}			260	400	ns
t_{fi}			150		ns
E_{off}			2.2	4.5	mJ
t_{d(on)}	Inductive load, T_J = 125°C I _C = I _{C110} A, V _{GE} = 15 V V _{CE} = 720 V, R _G = R _{off} = 5 Ω		20	ns	
t_{ri}			22	ns	
E_{on}			3.8		mJ
t_{d(off)}			360		ns
t_{fi}			330		ns
E_{off}		5.75		mJ	
R_{thJC}				0.42 K/W	
R_{thCS}	(TO-247)	0.25		K/W	

Ultrafast Diode

Symbol	Conditions	Maximum Ratings	
I_{F110}	T _C = 110°C	27	A

Symbol	Conditions	Characteristic Values		
		(T _J = 25°C unless otherwise specified)		
		Min.	Typ.	Max.
V_F	I _F = 30 A; T _{VJ} = 125°C		1.9	2.75 V
I_{RM}	I _F = 50 A; di _F /dt = -100 A/μs; T _{VJ} = 100°C V _R = 100 V; V _{GE} = 0 V		5.5	11.4 A
t_{rr}				190
R_{thJC}				0.9 K/W
R_{thCS}		0.25		K/W

TO-247 AD Outline

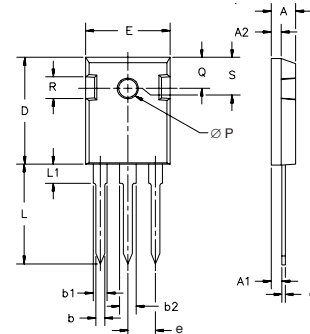

Dim.	Millimeter		Inches	
	Min.	Max.	Min.	Max.
A	4.7	5.3	.185	.209
A ₁	2.2	2.54	.087	.102
A ₂	2.2	2.6	.059	.098
b	1.0	1.4	.040	.055
b ₁	1.65	2.13	.065	.084
b ₂	2.87	3.12	.113	.123
C	.4	.8	.016	.031
D	20.80	21.46	.819	.845
E	15.75	16.26	.610	.640
e	5.20	5.72	0.205	0.225
L	19.81	20.32	.780	.800
L1		4.50		.177
∅P	3.55	3.65	.140	.144
Q	5.89	6.40	0.232	0.252
R	4.32	5.49	.170	.216
S	6.15	BSC	.242	BSC

TO-268 Outline

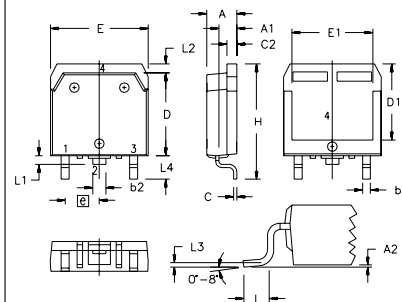

SYM	INCHES		MILLIMETERS	
	MIN	MAX	MIN	MAX
A	.193	.201	4.90	5.10
A1	.106	.114	2.70	2.90
A2	.001	.010	0.02	0.25
b	.045	.057	1.15	1.45
b2	.075	.083	1.90	2.10
C	.016	.026	0.40	0.65
C2	.057	.063	1.45	1.60
D	.543	.551	13.80	14.00
D1	.488	.500	12.40	12.70
E	.624	.632	15.85	16.05
E1	.524	.535	13.30	13.60
e		.215 BSC		5.45 BSC
H	.736	.752	18.70	19.10
L	.094	.106	2.40	2.70
L1	.047	.055	1.20	1.40
L2	.039	.045	1.00	1.15
L3	.010	BSC		0.25 BSC
L4	.150	.161	3.80	4.10

IXYS reserves the right to change limits, test conditions, and dimensions.

IXYS MOSFETs and IGBTs are covered by one or more of the following U.S. patents:	4,835,592	4,931,844	5,049,961	5,237,481	6,162,665	6,404,065 B1	6,683,344	6,727,585
	4,850,072	5,017,508	5,063,307	5,381,025	6,259,123 B1	6,534,343	6,710,405 B2	6,759,692
	4,881,106	5,034,796	5,187,117	5,486,715	6,306,728 B1	6,583,505	6,710,463	6,771,478 B2

Fig. 1. Output Characteristics
@ 25 °C

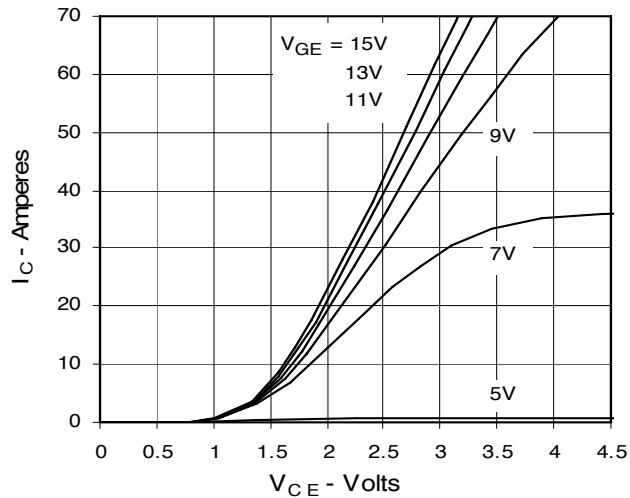

Fig. 2. Extended Output Characteristics
@ 25 °C

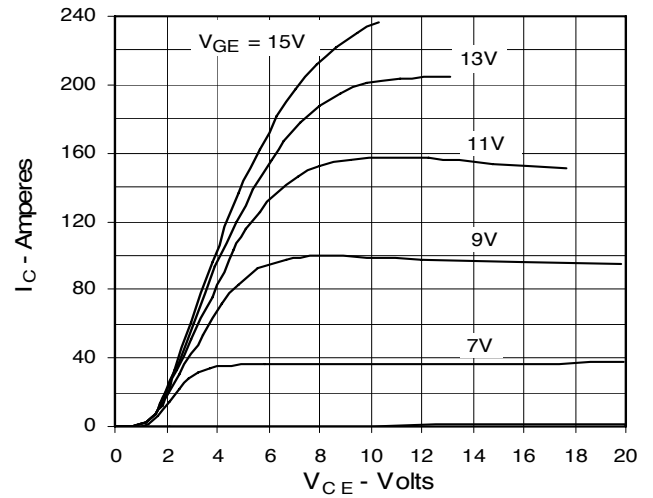

Fig. 3. Output Characteristics
@ 125 °C

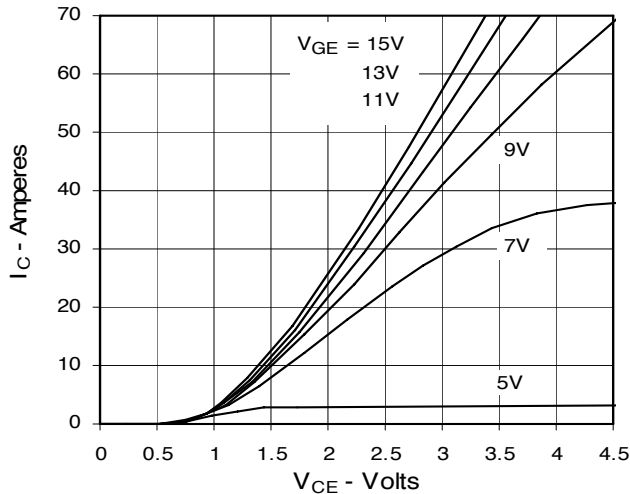

Fig. 4. Dependence of $V_{CE(sat)}$ on Temperature

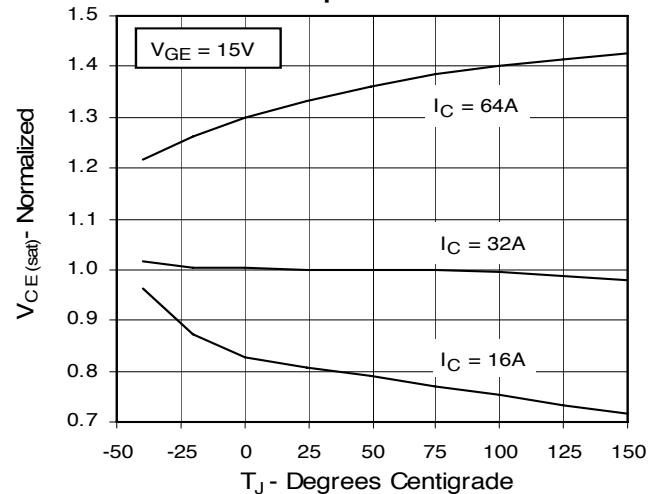

Fig. 5. Collector-to-Emitter Voltage vs. Gate-to-Emitter voltage

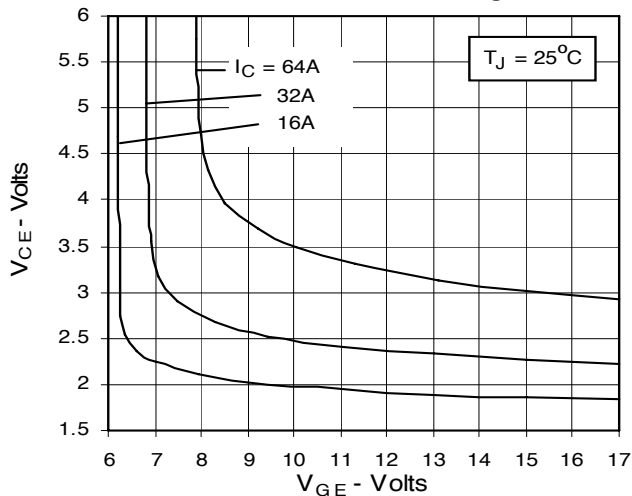

Fig. 6. Input Admittance

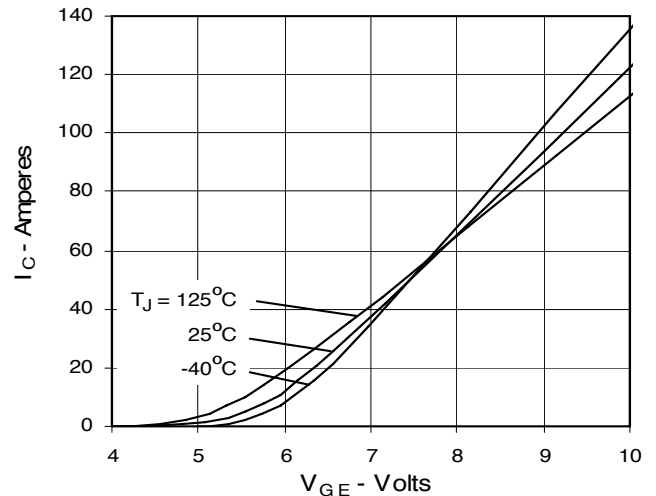

Fig. 7. Transconductance

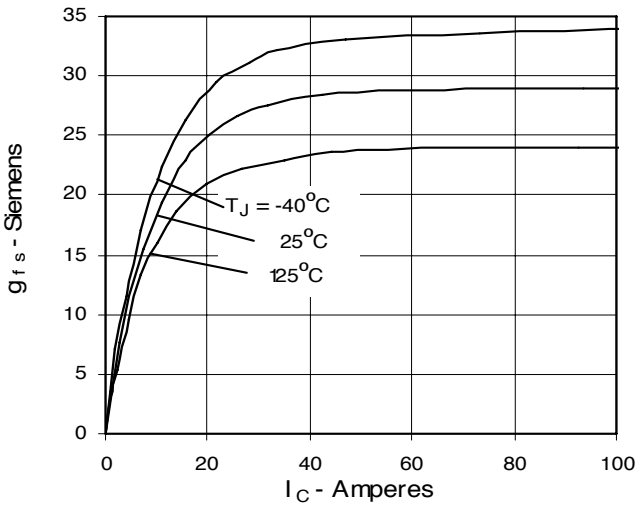

Fig. 8. Gate Charge

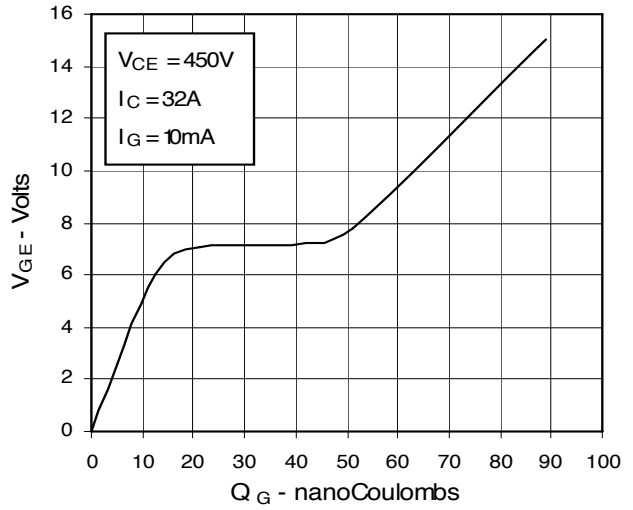

Fig. 9. Capacitance

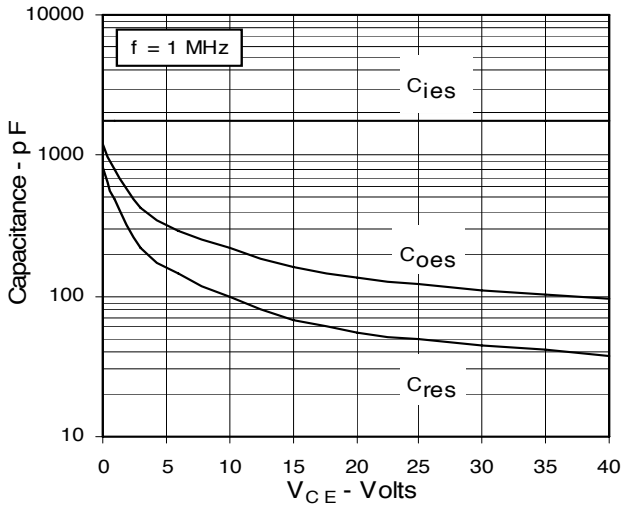

Fig. 10. Reverse-Bias Safe Operating Area

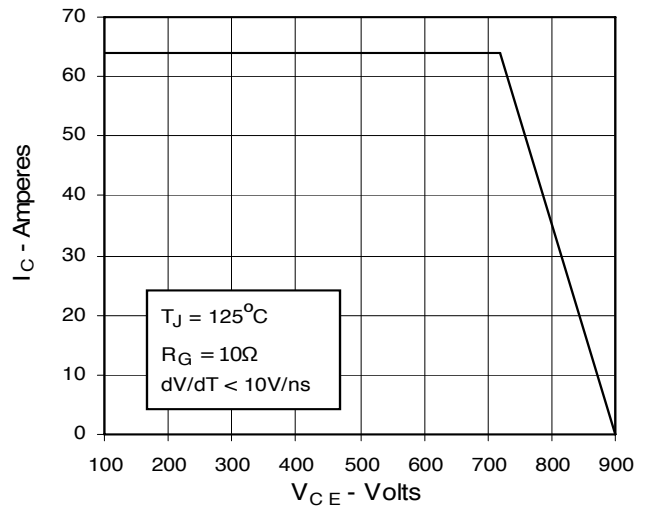

Fig. 11. Maximum Transient Thermal Resistance

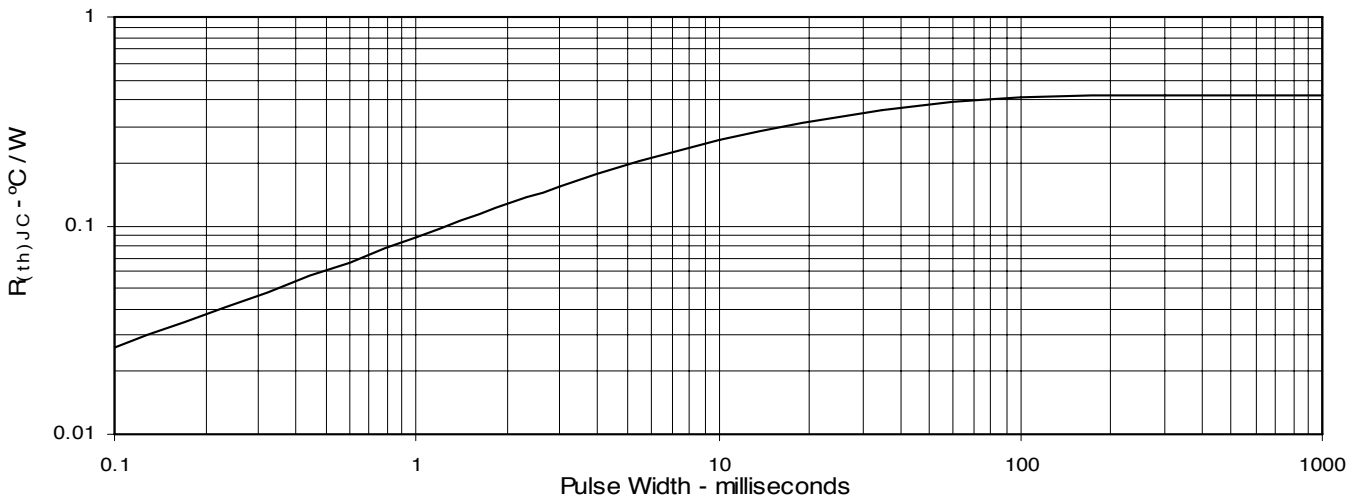

Fig. 12. Dependence of Turn-off Energy Loss on Gate Resistance

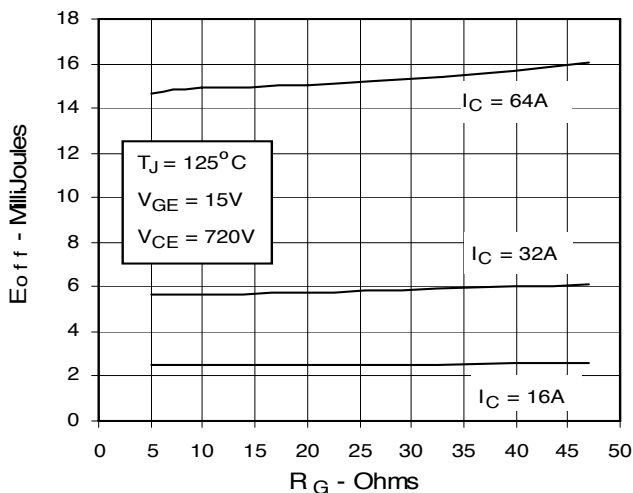

Fig. 13. Dependence of Turn-on Energy Loss on Gate Resistance

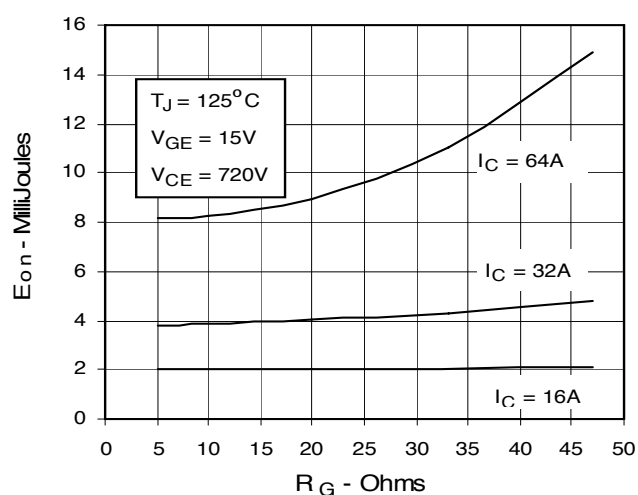

Fig. 14. Dependence of Turn-off Energy Loss on Collector Current

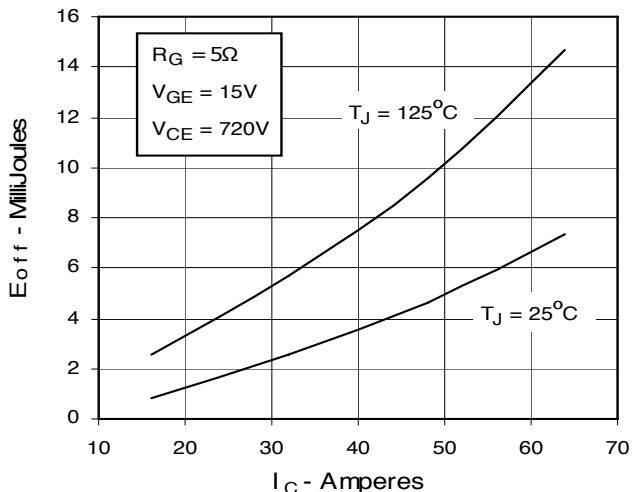

Fig. 15. Dependence of Turn-on Energy Loss on Collector Current

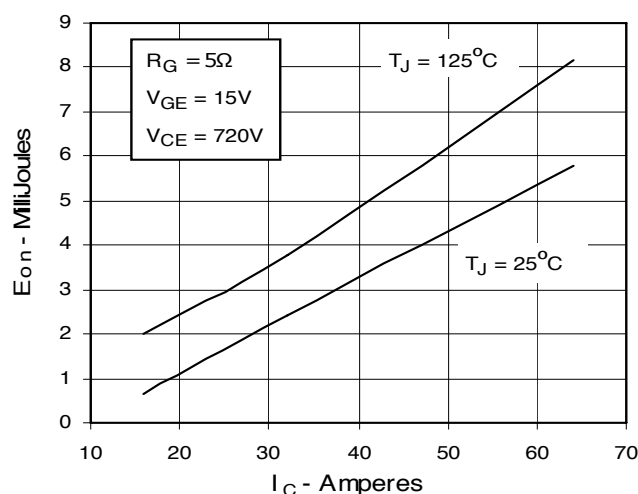

Fig. 16. Dependence of Turn-off Energy Loss on Temperature

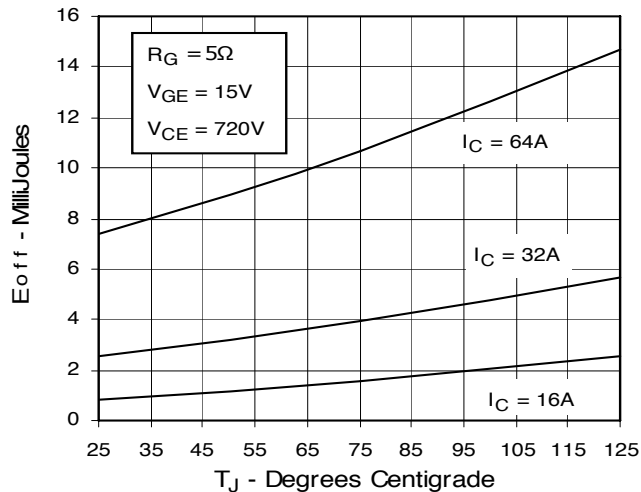

Fig. 17. Dependence of Turn-on Energy Loss on Temperature

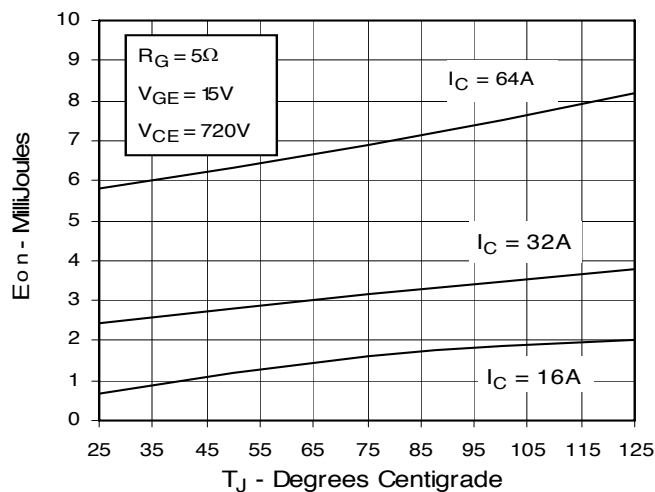

Fig. 18. Dependence of Turn-off Switching Time on Gate Resistance

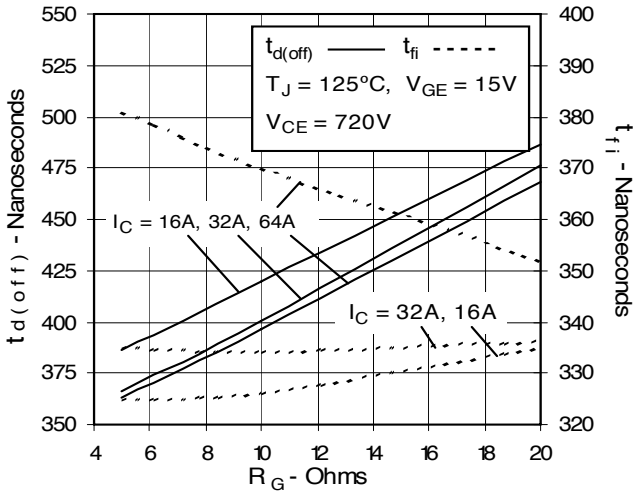

Fig. 19. Dependence of Turn-on Switching Time on Gate Resistance

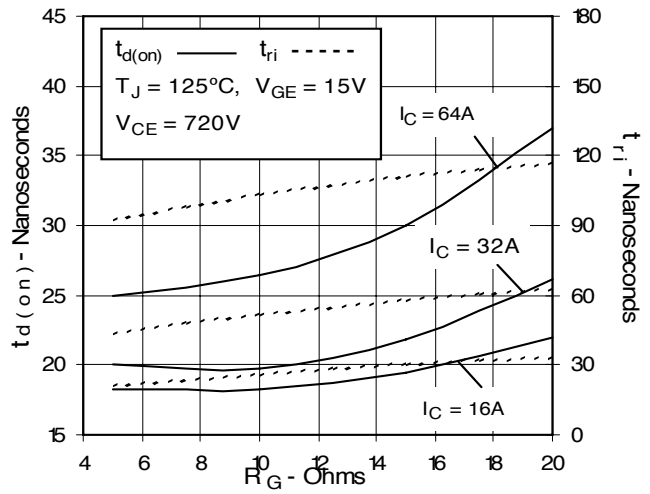

Fig. 20. Dependence of Turn-off Switching Time on Collector Current

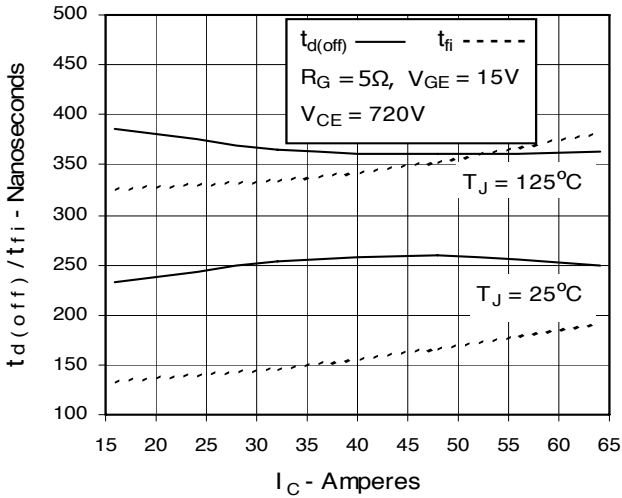

Fig. 21. Dependence of Turn-on Switching Time on Collector Current

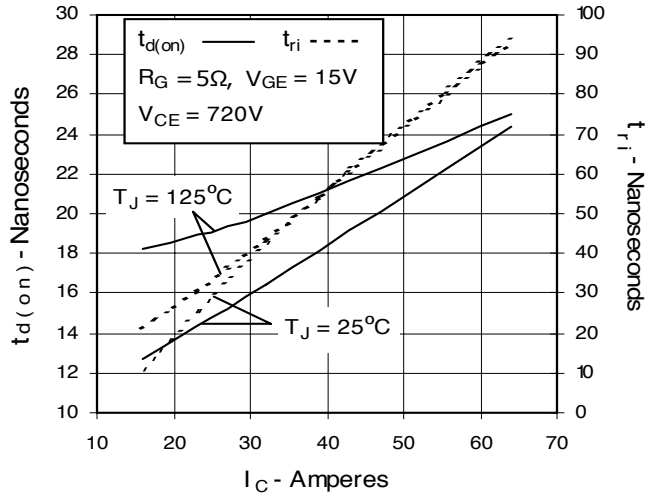

Fig. 22. Dependence of Turn-off Switching Time on Temperature

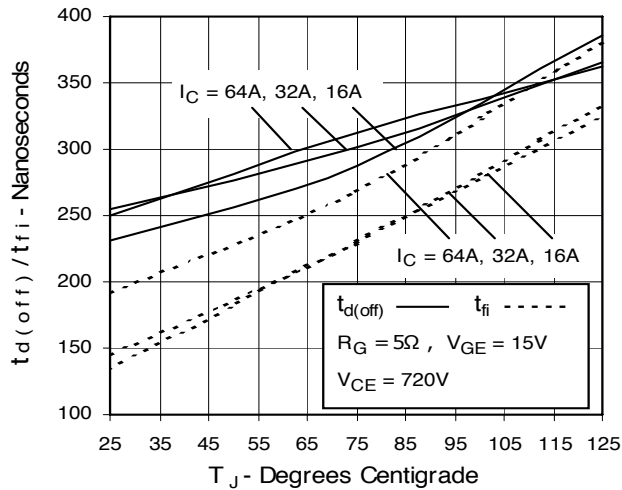
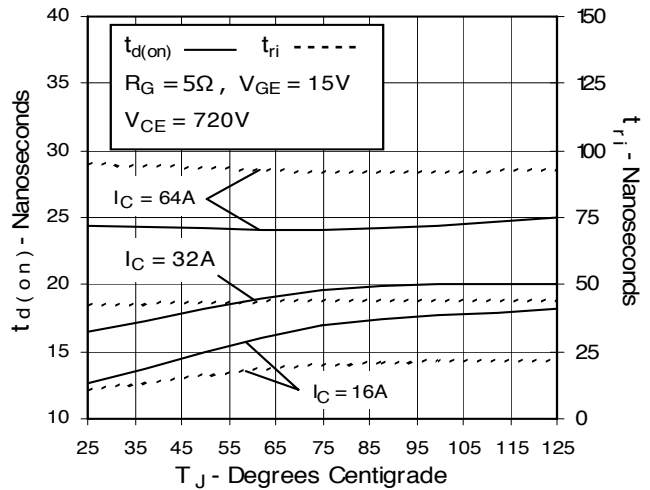

Fig. 23. Dependence of Turn-on Switching Time on Temperature



Ultrafast Diode Characteristic Curves

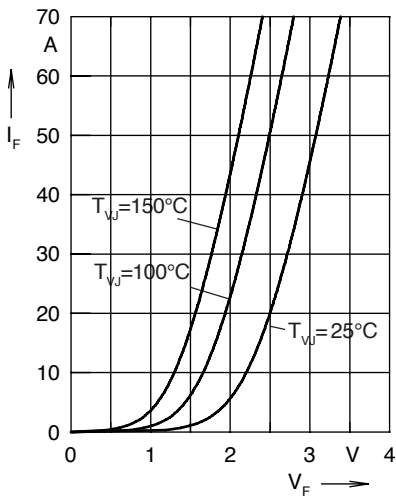

Fig. 24. Forward current I_F versus V_F

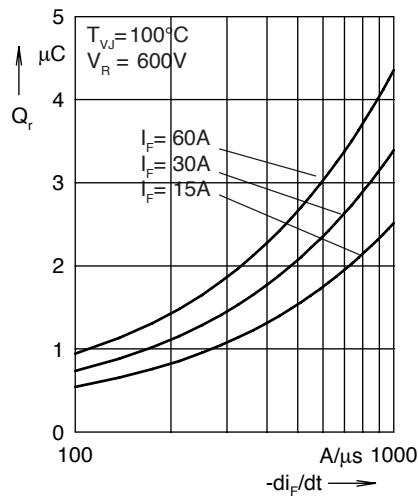

Fig. 25. Reverse recovery charge Q_r versus $-di_F/dt$

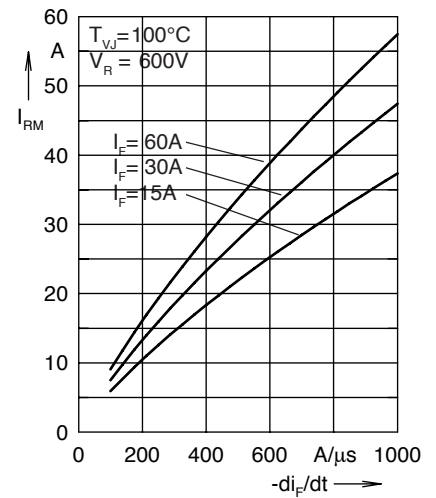

Fig. 26. Peak reverse current I_{RM} versus $-di_F/dt$

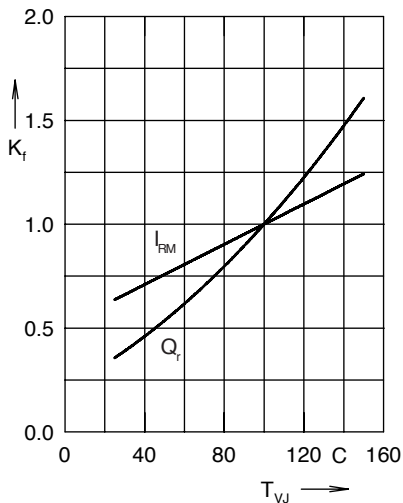

Fig. 27. Dynamic parameters Q_r , I_{RM} versus T_{VJ}

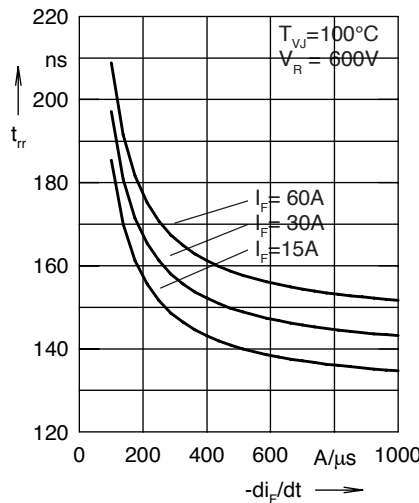

Fig. 28. Recovery time t_{tr} versus $-di_F/dt$

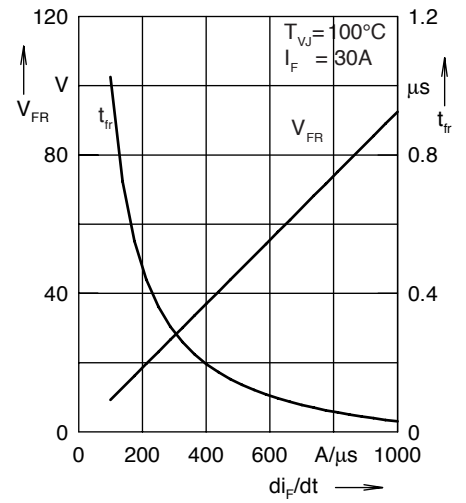

Fig. 29. Peak forward voltage V_{FR} and t_{tr} versus di_F/dt

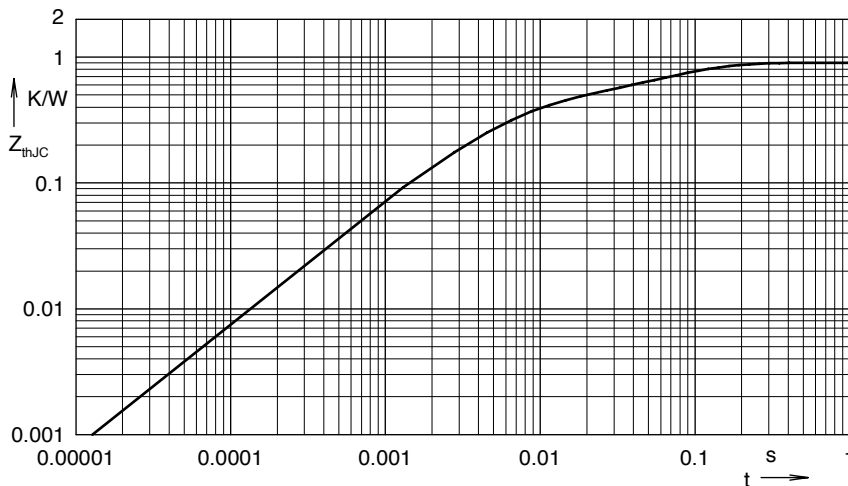

Fig. 30. Transient thermal resistance junction to case

Constants for Z_{thJC} calculation:

i	R_{thi} (K/W)	t_i (s)
1	0.465	0.0052
2	0.179	0.0003
3	0.256	0.0397



Disclaimer Notice - Information furnished is believed to be accurate and reliable. However, users should independently evaluate the suitability of and test each product selected for their own applications. Littelfuse products are not designed for, and may not be used in, all applications. Read complete Disclaimer Notice at www.littelfuse.com/disclaimer-electronics.