

INTEGRATED RELAY AND INDUCTIVE LOAD DRIVER
Product Summary

BV _{bss}	R _{DS(ON)} Max	I _D Max T _A = +25°C
60V	1.8Ω @ V _{GS} = 5V	470mA
	2.4Ω @ V _{GS} = 3V	

Description and Applications

The DMN61D8LQ provides a single component solution for switching inductive loads such as relays, solenoids, and small DC motors in automotive applications, without the need of a freewheeling diode. DMN61D8LQ accepts logic level inputs, thus allowing it to be driven by logic gates, inverters, and microcontrollers.

Features and Benefits

- Provides A More Reliable And Robust Interface Between Sensitive Logic And DC Relay Coils
- Replaces 3 to 4 Discrete Components Enabling PCB Footprint To Be Reduced
- Internal Active Clamp Removes The Need For External Zener Diode
- **Totally Lead-Free & Fully RoHS Compliant (Notes 1 & 2)**
- **Halogen and Antimony Free. "Green" Device (Note 3)**
- **Qualified to AEC-Q101 Standards for High Reliability**
- **PPAP Capable (Note 4)**

Mechanical Data

- Case: SOT23
- Case Material: Molded Plastic, "Green" Molding Compound. UL Flammability Classification Rating 94V-0
- Moisture Sensitivity: Level 1 per J-STD-020
- Terminals: Matte Tin Finish Annealed over Alloy 42 Leadframe (Lead-Free Plating). Solderable per MIL-STD-202, Method 208 (3)
- Terminal Connections: See Diagram
- Weight: 0.008 grams (Approximate)

ESD protected

Top View

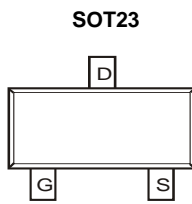
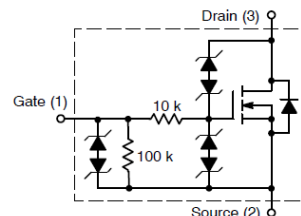

 Top View
Internal Schematic

Equivalent Circuit

Ordering Information (Note 5)

Part Number	Case	Packaging
DMN61D8LQ-7	SOT23	3,000/Tape & Reel
DMN61D8LQ-13	SOT23	10,000/Tape & Reel

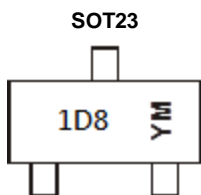
- Notes:
1. No purposely added lead. Fully EU Directive 2002/95/EC (RoHS) & 2011/65/EU (RoHS 2) compliant.
 2. See http://www.diodes.com/quality/lead_free.html for more information about Diodes Incorporated's definitions of Halogen- and Antimony-free, "Green" and Lead-free.
 3. Halogen- and Antimony-free "Green" products are defined as those which contain <900ppm bromine, <900ppm chlorine (<1500ppm total Br + Cl) and <1000ppm antimony compounds.
 4. Automotive products are AEC-Q101 qualified and are PPAP capable. Refer to http://www.diodes.com/product_compliance_definitions.html.
 5. For packaging details, go to our website at <http://www.diodes.com/products/packages.html>.

Marking Information

1D8 = Product Type Marking Code
 YM = Date Code Marking
 Y = Year (ex: D = 2016)
 M = Month (ex: 9 = September)

Date Code Key

Year	2016	2017	2018	2019	2020	2021	2022
Code	D	E	F	G	H	I	J

Month	Jan	Feb	Mar	Apr	May	Jun	Jul	Aug	Sep	Oct	Nov	Dec
Code	1	2	3	4	5	6	7	8	9	O	N	D

Maximum Ratings (@T_A = +25°C, unless otherwise specified.)

Characteristic			Symbol	Value	Unit
Drain-Source Voltage			V _{DSS}	60	V
Gate-Source Voltage			V _{GSS}	±12	V
Continuous Drain Current (Note 7)	Steady State	T _A = +25°C	I _D	470	mA
		T _A = +70°C		370	
Maximum Continuous Body Diode Forward Current (Note 6)			I _S	0.5	A
Single Pulse Drain-to-Source Avalanche Energy (For Relay's Coils/Inductive Loads of 80Ω or Higher) (T _J Initial = +85°C)			E _Z	200	mJ
Peak Power Dissipation, Drain-to-Source (Non repetitive current square pulse 1.0ms duration) (T _J Initial = +85°C)			P _{PK}	20	W
Load Dump Pulse, Drain-to-Source, R _{SOURCE} = 0.5Ω, t = 300ms (For Relay's Coils/Inductive Loads of 80Ω or Higher) (T _J Initial = +85°C)			E _{LD1}	60	V
Inductive Switching Transient 1, Drain-to-Source (Waveform: R _{SOURCE} = 10Ω, t = 2.0ms) (For Relay's Coils/Inductive Loads of 80Ω or Higher) (T _J Initial = +85°C)			E _{LD2}	100	V
Inductive Switching Transient 2, Drain-to-Source (Waveform: R _{SOURCE} = 4.0Ω, t = 50μs) (For Relay's Coils/Inductive Loads of 80Ω or Higher) (T _J Initial = +85°C)			E _{LD3}	300	V
Reverse Battery, 10 Minutes (Drain-to-Source) (For Relay's Coils/Inductive Loads of 80Ω or more)			Rev-Bat	-14	V
Dual Voltage Jump Start, 10 Minutes (Drain-to-Source)			Dual-Volt	28	V
ESD Human Body Model (HBM)			ESD	4,000	V

Thermal Characteristics

Characteristic			Symbol	Value	Unit
Total Power Dissipation (Note 6)			P _D	390	mW
Thermal Resistance, Junction to Ambient (Note 6)	Steady State		R _{θJA}	321	°C/W
Total Power Dissipation (Note 7)			P _D	610	mW
Thermal Resistance, Junction to Ambient (Note 7)	Steady State		R _{θJA}	208	°C/W
Operating and Storage Temperature Range			T _J , T _{STG}	-55 to +150	°C

- Notes: 6. Device mounted on FR-4 PCB, with minimum recommended pad layout.
7. Device mounted on 1" x 1" FR-4 PCB with high coverage 2oz. copper, single sided.

Electrical Characteristics (@T_A = +25°C, unless otherwise specified.)

Characteristic	Symbol	Min	Typ	Max	Unit	Test Condition
OFF CHARACTERISTICS (Note 8)						
Drain-Source Breakdown Voltage	BV _{DSS}	60	—	—	V	V _{GS} = 0V, I _D = 10mA
Zero Gate Voltage Drain Current	I _{DSS}	—	—	50 0.5	μA	V _{DS} = 60V, V _{GS} = 0V V _{DS} = 12V, V _{GS} = 0V
Gate-Source Leakage	I _{GSS}	—	—	±90 ±60	μA	V _{GS} = ±5V, V _{DS} = 0V V _{GS} = ±3V, V _{DS} = 0V
ON CHARACTERISTICS (Note 8)						
Gate Threshold Voltage	V _{GS(TH)}	1.3	—	2.0	V	V _{DS} = V _{GS} , I _D = 1mA
Static Drain-Source On-Resistance	R _{DS(ON)}	—	1.1	1.8	Ω	V _{GS} = 5V, I _D = 0.15A
			1.4	2.4		V _{GS} = 3V, I _D = 0.15A
Forward Transfer Admittance	Y _{fs}	80	—	—	ms	V _{DS} = 12V, I _D = 0.15A
Diode Forward Voltage	V _{SD}	—	—	1.2	V	V _{GS} = 0V, I _S = 0.15A
DYNAMIC CHARACTERISTICS (Note 9)						
Input Capacitance	C _{iss}	—	12.9	—	pF	V _{DS} = 12V, V _{GS} = 0V f = 1.0MHz
Output Capacitance	C _{oss}	—	17	—	pF	
Reverse Transfer Capacitance	C _{rss}	—	0.84	—	pF	
Total Gate Charge	Q _g	—	0.74	—	nC	V _{GS} = 5V, V _{DS} = 12V, I _D = 150mA
Gate-Source Charge	Q _{gs}	—	0.19	—	nC	
Gate-Drain Charge	Q _{gd}	—	0.16	—	nC	
Turn-On Delay Time	t _{D(ON)}	—	131	—	ns	V _{DD} = 12V, V _{GS} = 5V.
Turn-On Rise Time	t _r	—	301	—	ns	
Turn-Off Delay Time	t _{D(OFF)}	—	582	—	ns	
Turn-Off Fall Time	t _f	—	440	—	ns	

Notes: 8. Short duration pulse test used to minimize self-heating effect.
9. Guaranteed by design. Not subject to product testing.

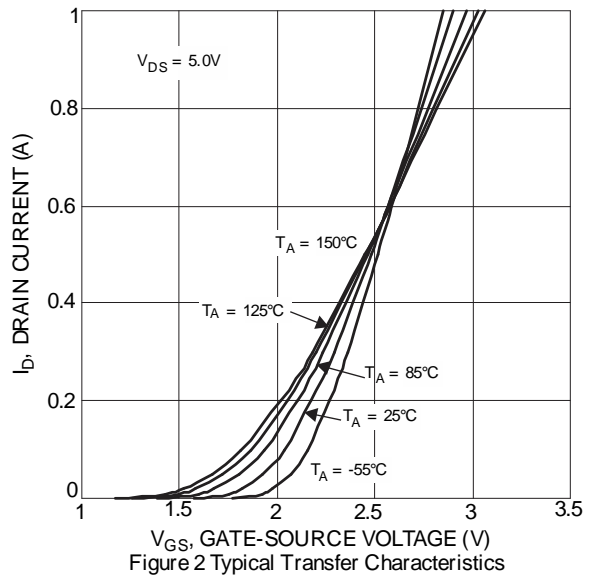
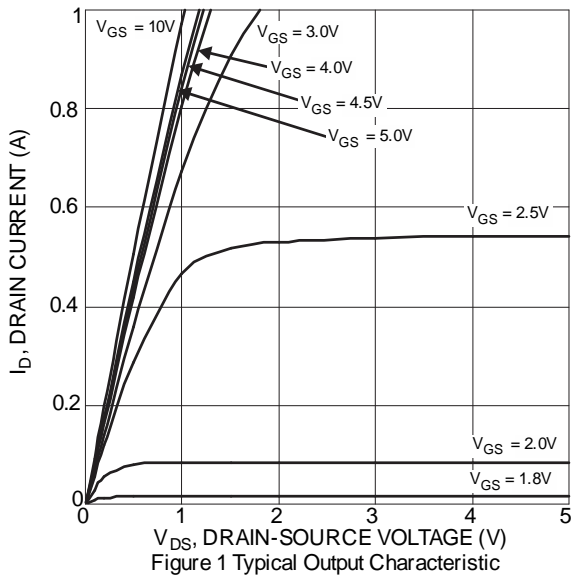

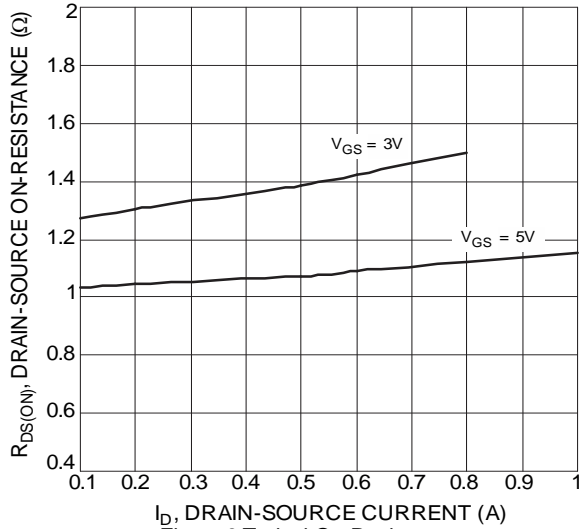

Figure 3 Typical On-Resistance vs. Drain Current and Gate Voltage

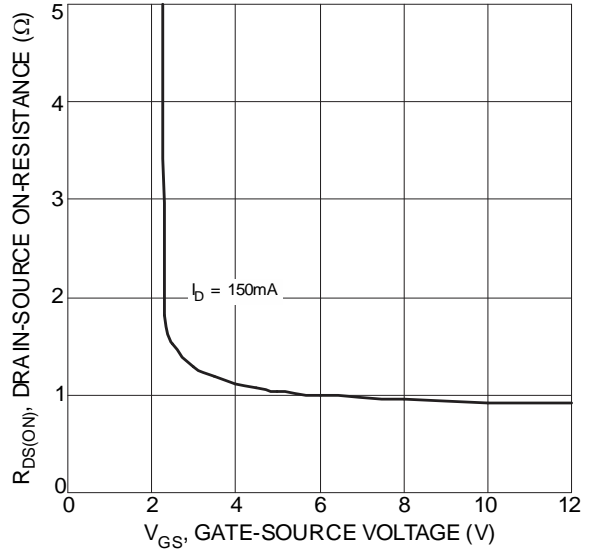

Figure 4 Typical Transfer Characteristic

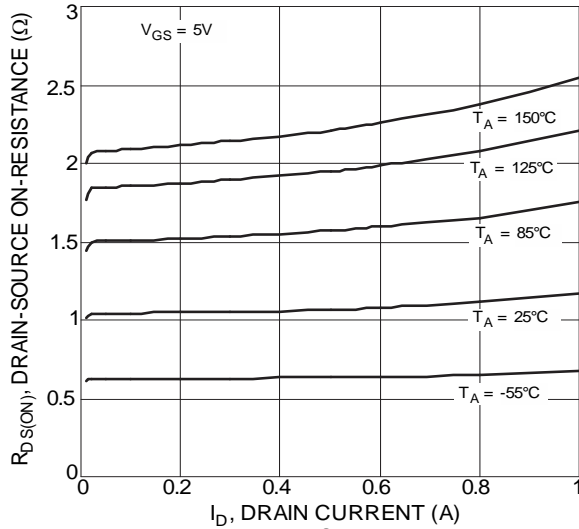

Figure 5 Typical On-Resistance vs. Drain Current and Temperature

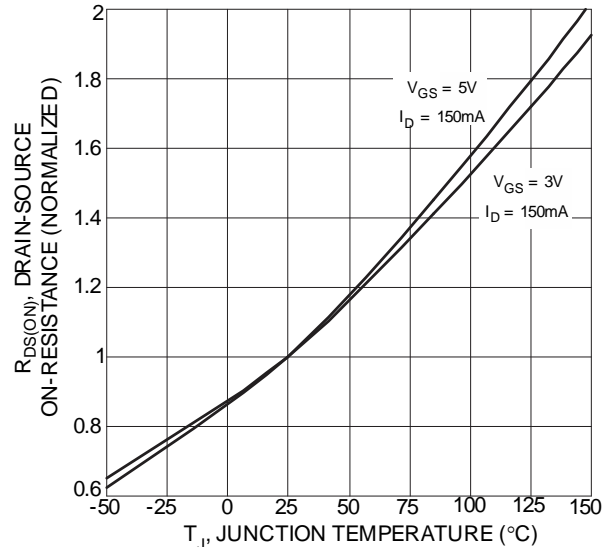

Figure 6 On-Resistance Variation with Temperature

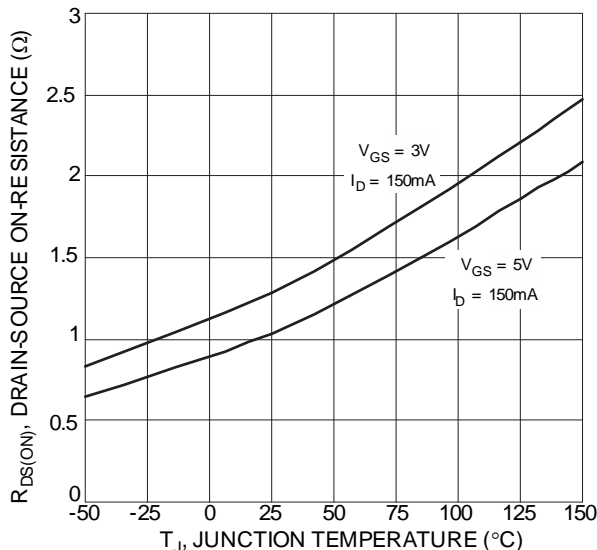

Figure 7 On-Resistance Variation with Temperature

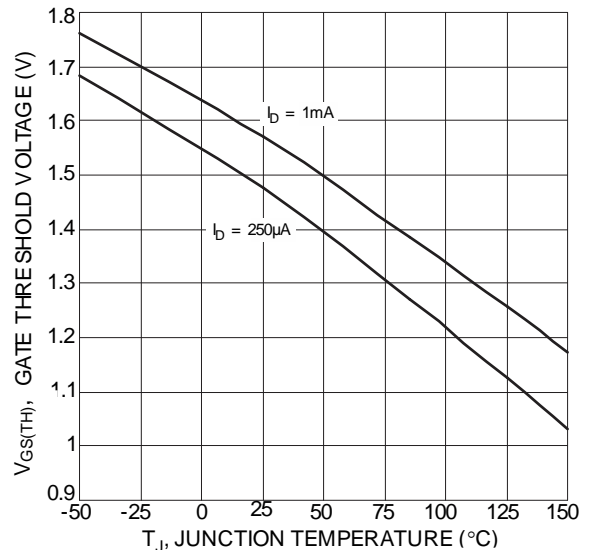
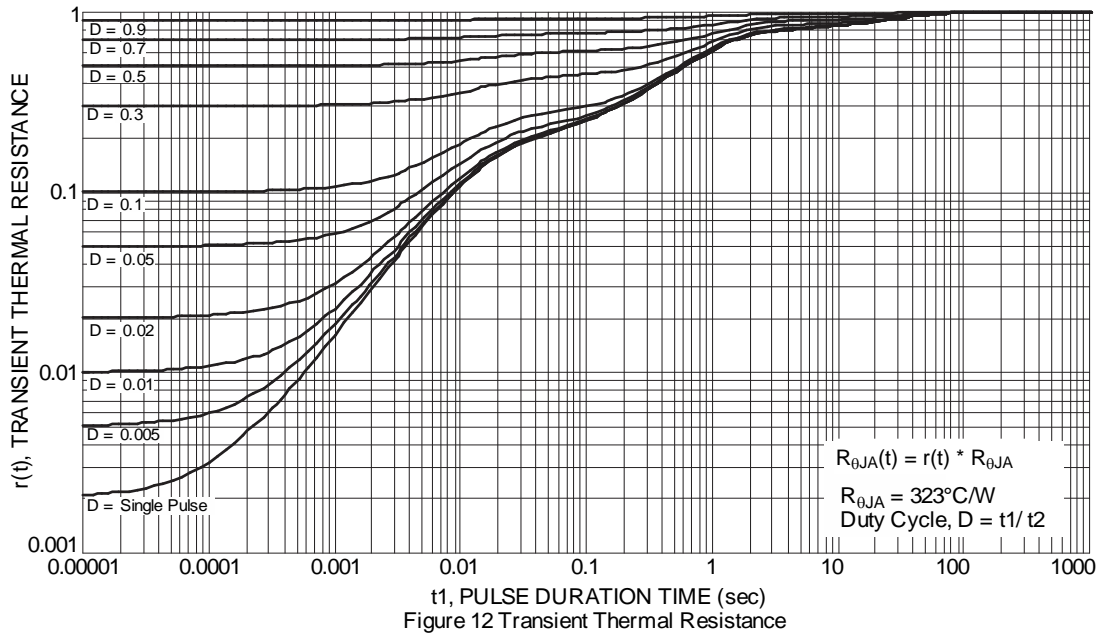
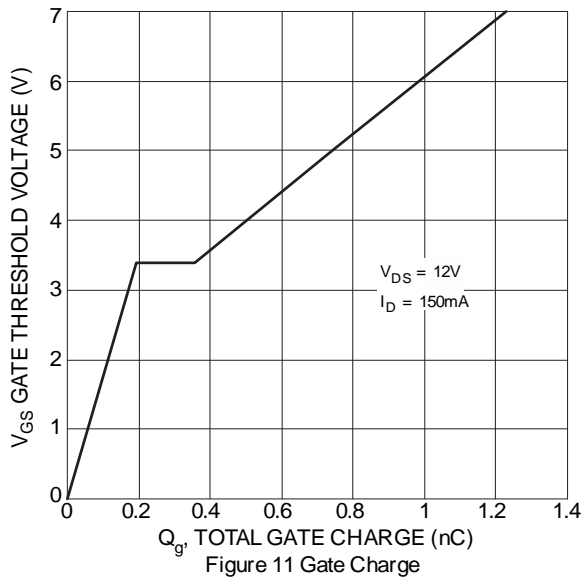
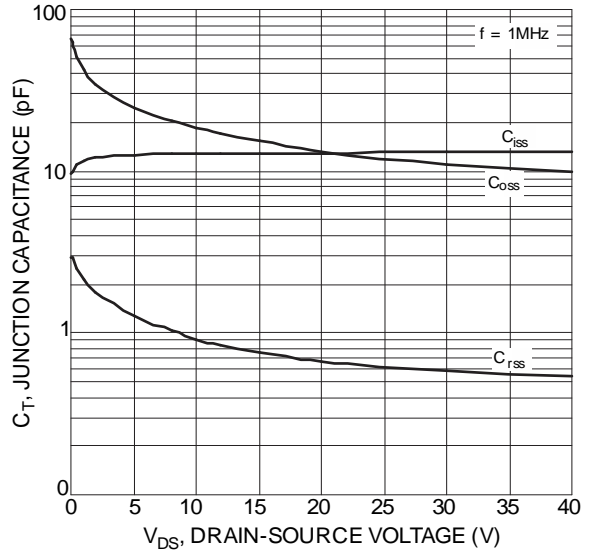
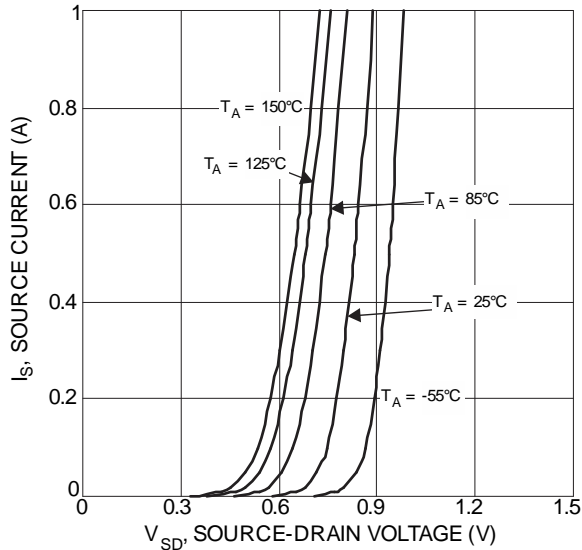

Figure 8 Gate Threshold Variation vs. Junction Temperature



Package Outline Dimensions

Please see <http://www.diodes.com/package-outlines.html> for the latest version.

SOT23

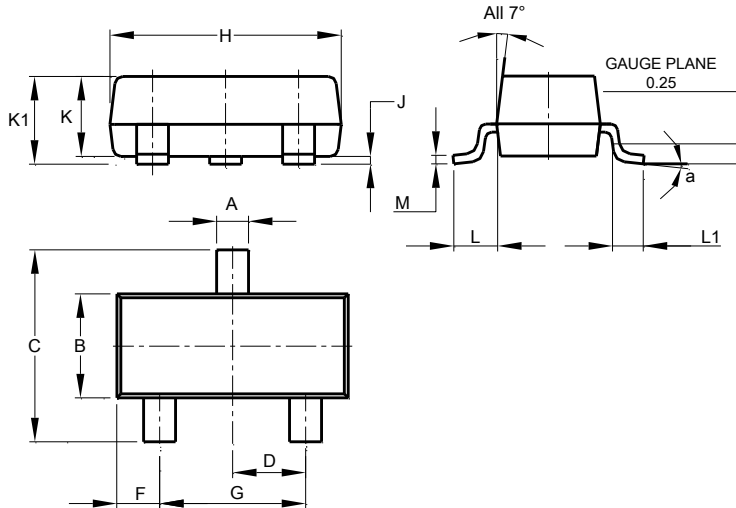

SOT23			
Dim	Min	Max	Typ
A	0.37	0.51	0.40
B	1.20	1.40	1.30
C	2.30	2.50	2.40
D	0.89	1.03	0.915
F	0.45	0.60	0.535
G	1.78	2.05	1.83
H	2.80	3.00	2.90
J	0.013	0.10	0.05
K	0.890	1.00	0.975
K1	0.903	1.10	1.025
L	0.45	0.61	0.55
L1	0.25	0.55	0.40
M	0.085	0.150	0.110
a	0°	8°	--
All Dimensions in mm			

Suggested Pad Layout

Please see <http://www.diodes.com/package-outlines.html> for the latest version.

SOT23

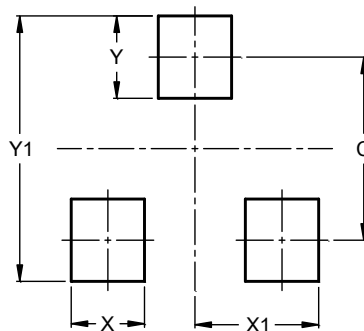

Dimensions	Value (in mm)
C	2.0
X	0.8
X1	1.35
Y	0.9
Y1	2.9

IMPORTANT NOTICE

DIODES INCORPORATED MAKES NO WARRANTY OF ANY KIND, EXPRESS OR IMPLIED, WITH REGARDS TO THIS DOCUMENT, INCLUDING, BUT NOT LIMITED TO, THE IMPLIED WARRANTIES OF MERCHANTABILITY AND FITNESS FOR A PARTICULAR PURPOSE (AND THEIR EQUIVALENTS UNDER THE LAWS OF ANY JURISDICTION).

Diodes Incorporated and its subsidiaries reserve the right to make modifications, enhancements, improvements, corrections or other changes without further notice to this document and any product described herein. Diodes Incorporated does not assume any liability arising out of the application or use of this document or any product described herein; neither does Diodes Incorporated convey any license under its patent or trademark rights, nor the rights of others. Any Customer or user of this document or products described herein in such applications shall assume all risks of such use and will agree to hold Diodes Incorporated and all the companies whose products are represented on Diodes Incorporated website, harmless against all damages.

Diodes Incorporated does not warrant or accept any liability whatsoever in respect of any products purchased through unauthorized sales channel. Should Customers purchase or use Diodes Incorporated products for any unintended or unauthorized application, Customers shall indemnify and hold Diodes Incorporated and its representatives harmless against all claims, damages, expenses, and attorney fees arising out of, directly or indirectly, any claim of personal injury or death associated with such unintended or unauthorized application.

Products described herein may be covered by one or more United States, international or foreign patents pending. Product names and markings noted herein may also be covered by one or more United States, international or foreign trademarks.

This document is written in English but may be translated into multiple languages for reference. Only the English version of this document is the final and determinative format released by Diodes Incorporated.

LIFE SUPPORT

Diodes Incorporated products are specifically not authorized for use as critical components in life support devices or systems without the express written approval of the Chief Executive Officer of Diodes Incorporated. As used herein:

A. Life support devices or systems are devices or systems which:

1. are intended to implant into the body, or
2. support or sustain life and whose failure to perform when properly used in accordance with instructions for use provided in the labeling can be reasonably expected to result in significant injury to the user.

B. A critical component is any component in a life support device or system whose failure to perform can be reasonably expected to cause the failure of the life support device or to affect its safety or effectiveness.

Customers represent that they have all necessary expertise in the safety and regulatory ramifications of their life support devices or systems, and acknowledge and agree that they are solely responsible for all legal, regulatory and safety-related requirements concerning their products and any use of Diodes Incorporated products in such safety-critical, life support devices or systems, notwithstanding any devices- or systems-related information or support that may be provided by Diodes Incorporated. Further, Customers must fully indemnify Diodes Incorporated and its representatives against any damages arising out of the use of Diodes Incorporated products in such safety-critical, life support devices or systems.

Copyright © 2016, Diodes Incorporated

www.diodes.com