

Printed on 3 Feb 2021 16:39 (China Standard Time) from TE304429

LOC	DIST	REVISIONS					
		P	LTR	DESCRIPTION	DATE	DWN	APVD
-	-		CI	REVISED	14JUL2010	HMR	TM
			D	REVISED	17DEC2012	H.M	N.Y
			DI	REVISED	03FEB2021	F.Z	R.B

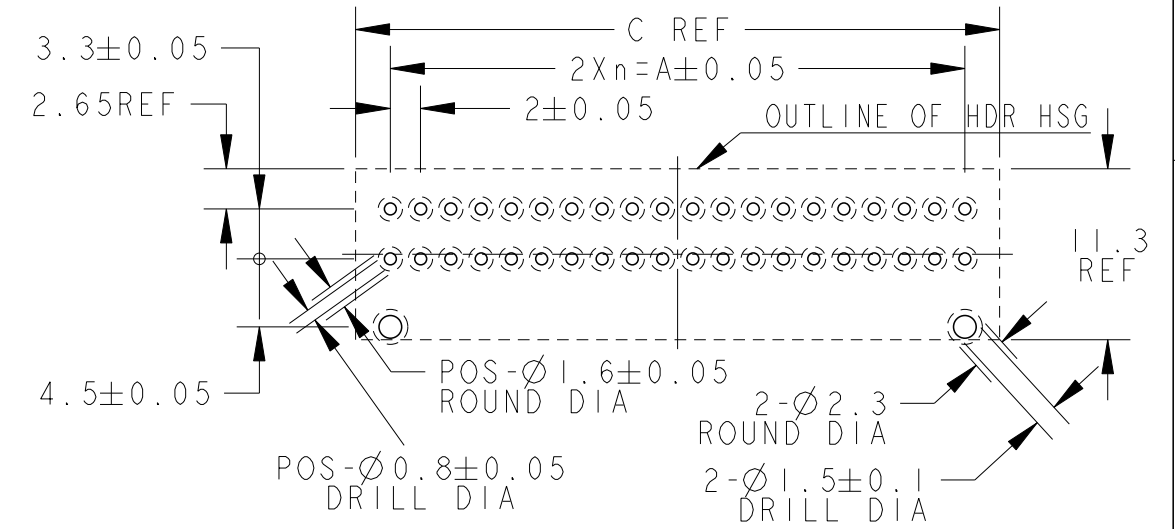

RECOMMEND PC BOARD HOLE PATTERN : CONNECTOR MOUNT SIDE (NOT ACCUMULATE TOLERANCE)
 PC BOARD THICKNESS : 1.0~1.6±0.1

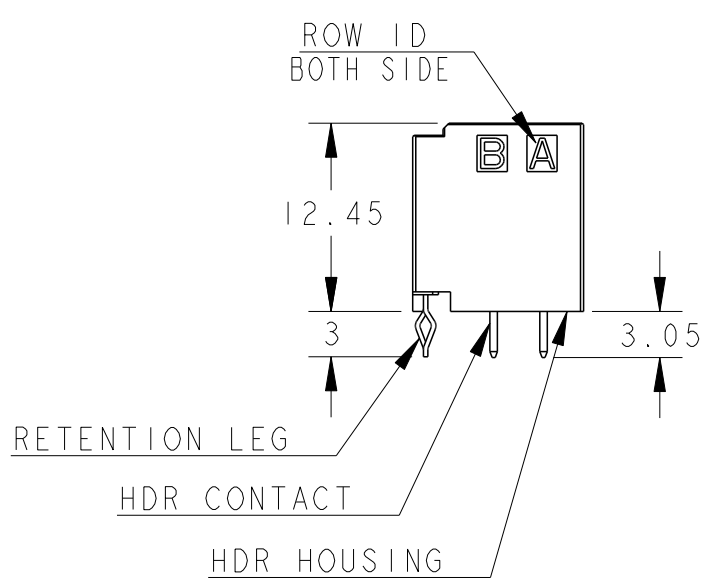
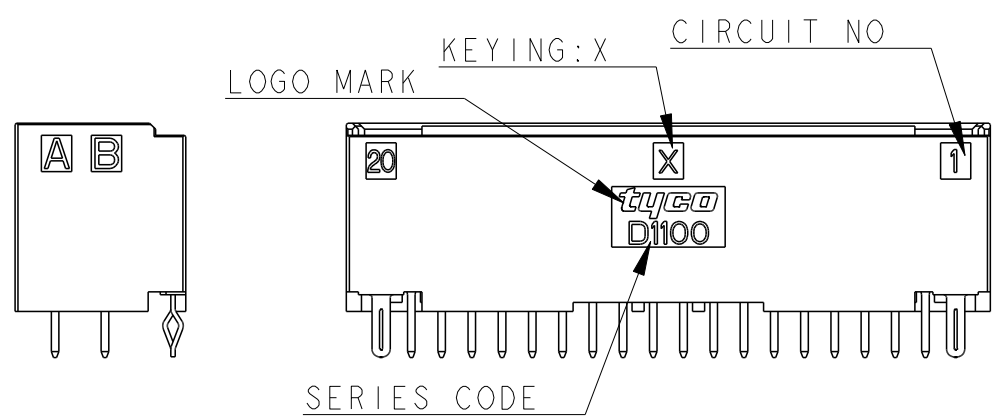
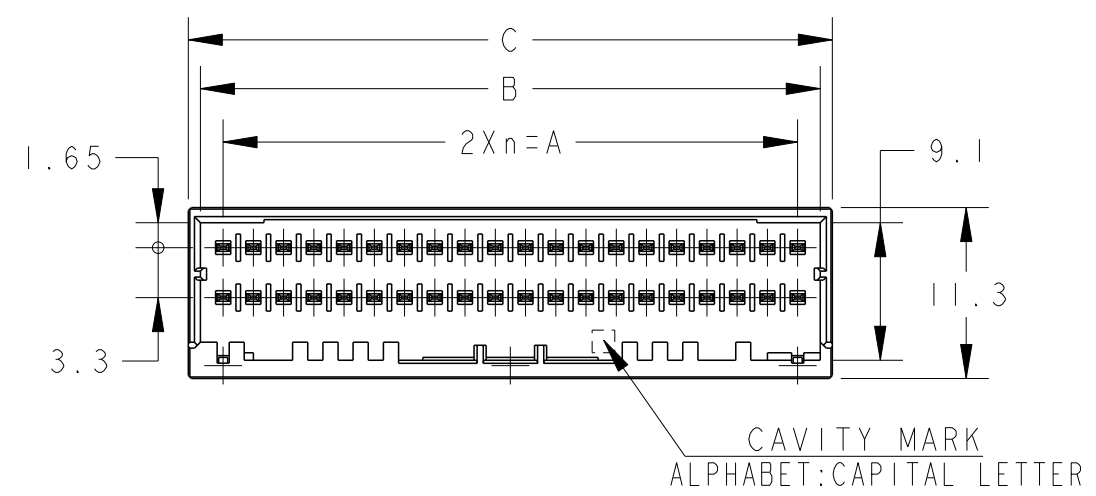
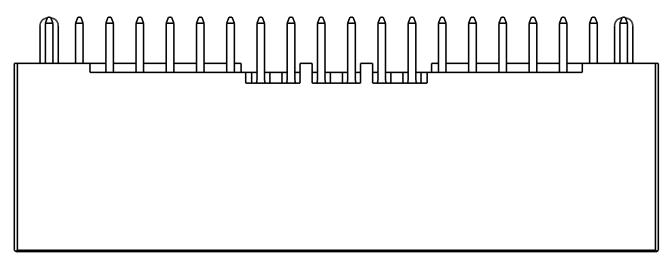
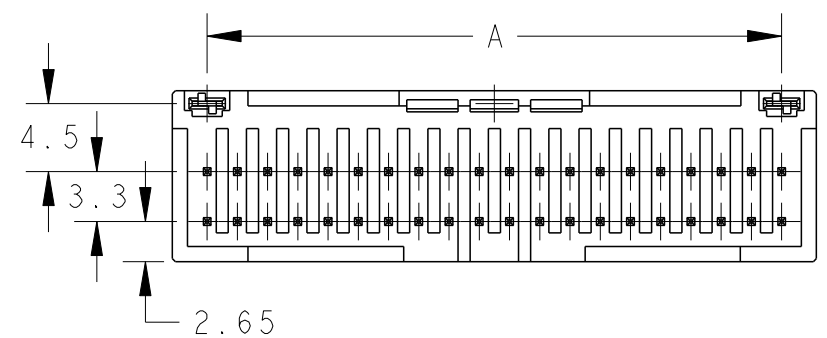

40POS(X-KEY): 1-1871315-0

1. MATERIAL: HOUSING: GLASS FILLED THERMO PLASTIC POLYESTER(94V-0)
 COLOR: BLACK
 CONTACT: PRE-TIN COPPER ALLOY
 RETENTION LEG: PRE-TIN COPPER ALLOY
 2. THE SHAPE, SIZE AND POSITION OF THE CHARACTER SHOW THE OUTLINE. THEY DON'T SHOW DETAILS.

40	X	19	38.0	41.0	42.6	PRE-TIN	1-1871315-0
34	Y	16	32.0	35.0	36.6	PRE-TIN	2-1871315-7
34	X	16	32.0	35.0	36.6	PRE-TIN	1-1871315-7
32	X	15	30.0	33.0	34.6	PRE-TIN	1-1871315-6
30	X	14	28.0	31.0	32.6	PRE-TIN	1-1871315-5
28	X	13	26.0	29.0	30.6	PRE-TIN	1-1871315-4
26	X	12	24.0	27.0	28.6	PRE-TIN	1-1871315-3
24	X	11	22.0	25.0	26.6	PRE-TIN	1-1871315-2
22	X	10	20.0	23.0	24.6	PRE-TIN	1-1871315-1
POS	KEY	n	A	B	C	FINISH	PART NO

THIS DRAWING IS A CONTROLLED DOCUMENT.		DWN T. KUDO 23AUG2005	TE Connectivity	
DIMENSIONS: mm		CHK D. MITSUGI 23AUG2005		
TOLERANCES UNLESS OTHERWISE SPECIFIED: ±0.3, ±5°		APVD D. MITSUGI 23AUG2005	NAME DYNAMIC D1100 SERIES HDR ASSY, V-TYPE, PRE-TIN 22~40POS	
0-PLC ±		PRODUCT SPEC 108-78298	SIZE A3	
1-PLC ±0.1		- 108-137366	CAGE CODE 00779	
2-PLC ±0.01		APPLICATION SPEC 114-5377	DRAWING NO C=1871315	
3-PLC ±0.001		WEIGHT -	RESTRICTED TO -	
4-PLC ±0.0001		CUSTOMER DRAWING	SCALE 2:1	
ANGLES ±			SHEET 1 OF 3	
FINISH -			REV DI	

4

3

2

1

THIS DRAWING IS UNPUBLISHED.

RELEASED FOR PUBLICATION

20

LOC J

DIST -

REVISIONS

© COPYRIGHT 2020 TE Connectivity. All Rights Reserved. ALL RIGHTS RESERVED.

P	LTR	DESCRIPTION	DATE	DWN	APVD
		SEE SHEET 1			

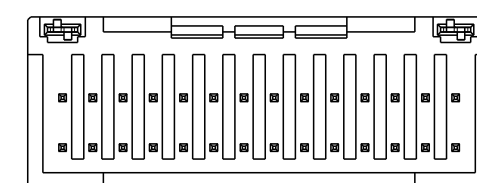
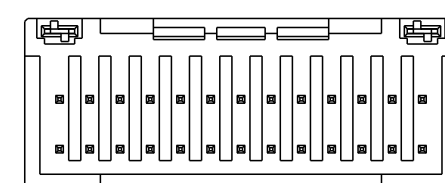
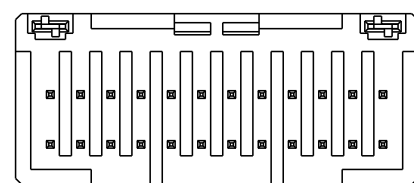
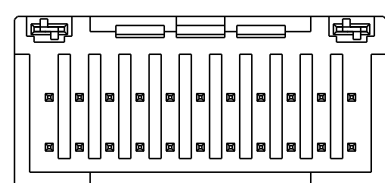
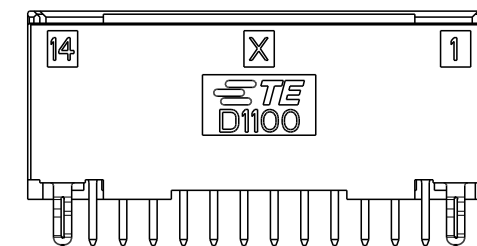
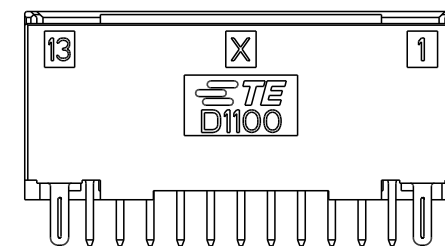
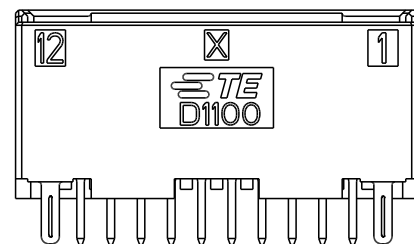
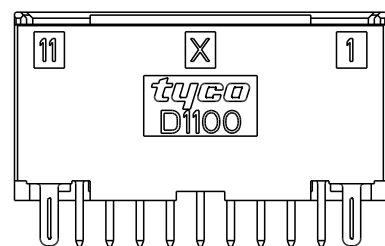
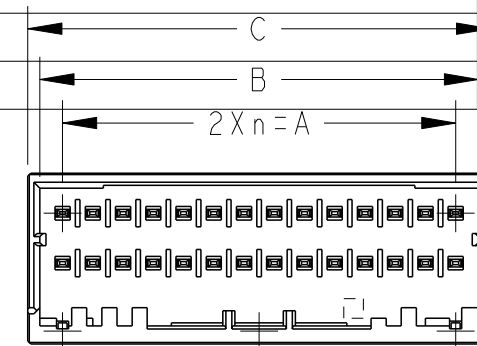
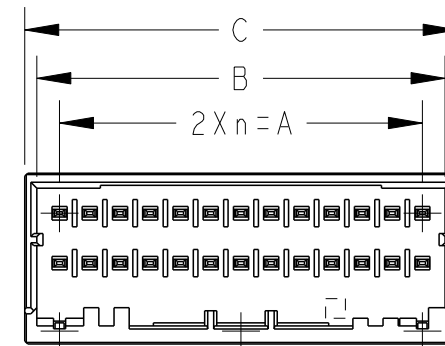
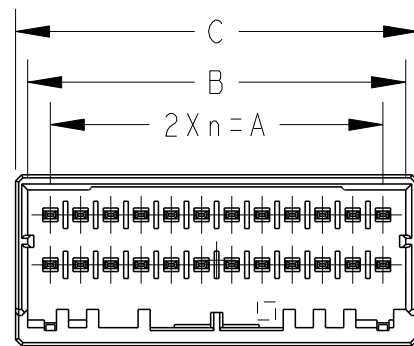
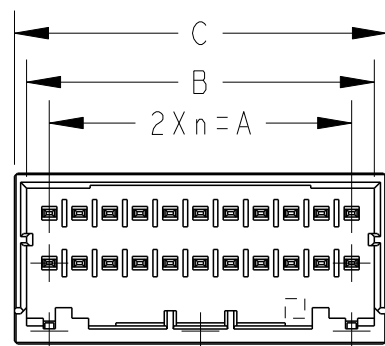

22POS(X-KEY)
1-1871315-1

24POS(X-KEY)
1-1871315-2

26POS(X-KEY)
1-1871315-3

28POS(X-KEY)
1-1871315-4

THIS DRAWING IS A CONTROLLED DOCUMENT.

DWN T. KUDO 03DEC2020

DIMENSIONS:
mm

TOLERANCES UNLESS OTHERWISE SPECIFIED:

CHK D. MITSUGI 23AUG2005

APVD D. MITSUGI 23AUG2005

PRODUCT SPEC 108-78298

108-137366

APPLICATION SPEC 114-5377

WEIGHT -

MATERIAL TBD

FINISH -



NAME DYNAMIC D1100 SERIES
HDR ASSY, V-TYPE, PRE-TIN
22~40POS

SIZE A3 CAGE CODE 00779 DRAWING NO C=1871315 RESTRICTED TO -

CUSTOMER DRAWING SCALE 2:1 SHEET 2 OF 3 REV D1

SEE SHEET 1 OF 2

Printed on 3 Feb 2021 16:39 (China Standard Time) from TE304429

4

3

2

1

THIS DRAWING IS UNPUBLISHED. RELEASED FOR PUBLICATION 20
© COPYRIGHT 2020 TE Connectivity. All Rights Reserved. ALL RIGHTS RESERVED.

LOC	DIST	REVISIONS					
		P	LTR	DESCRIPTION	DATE	DWN	APVD
-	-			SEE SHEET 1			

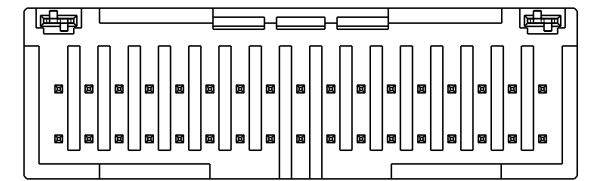
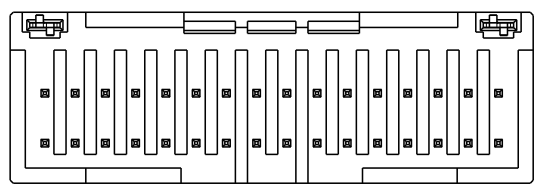
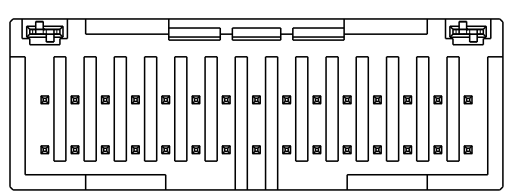
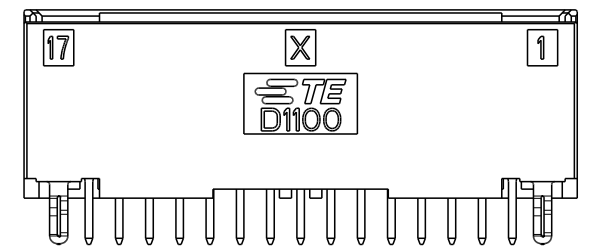
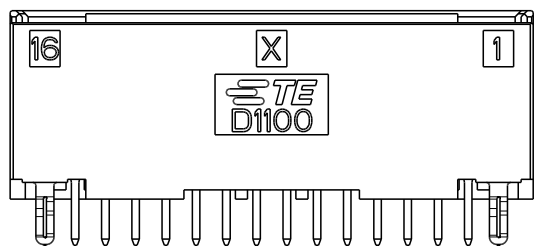
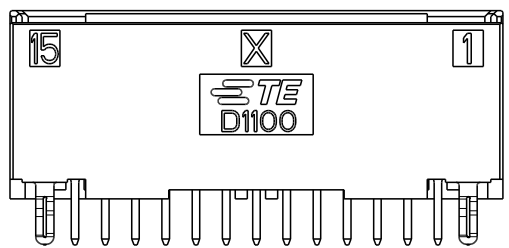
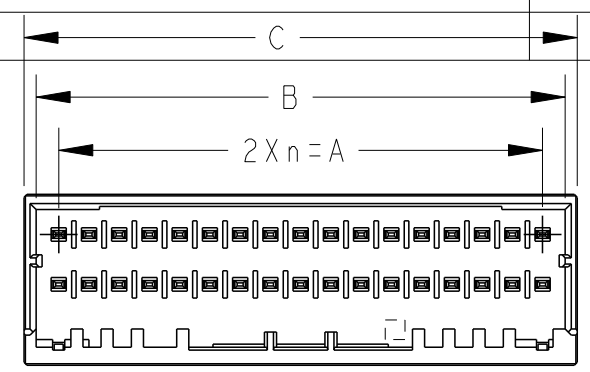
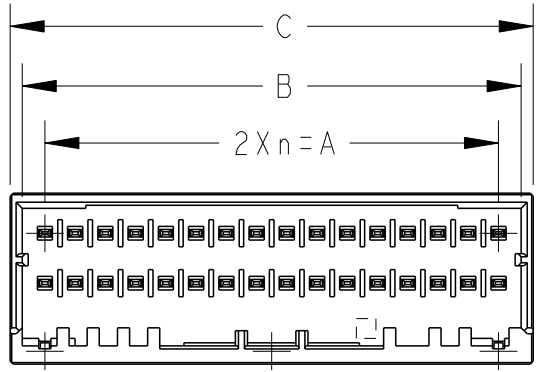
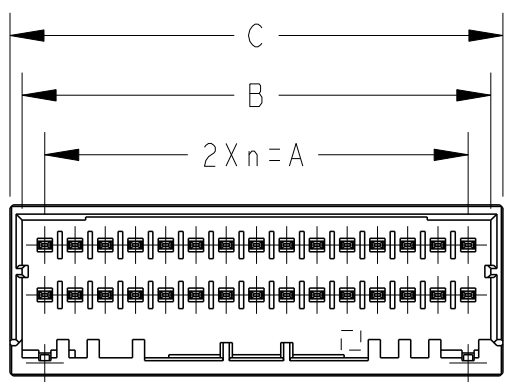

30POS(X-KEY)
1-1871315-5

32POS(X-KEY)
1-1871315-6

34POS(X-KEY)
1-1871315-7

NOTES: 2-1871315-7 IS SYMMETRY WITH 1-1871315-7 FOR KEY WAY

THIS DRAWING IS A CONTROLLED DOCUMENT.		DWN 03DEC2020 FISHER, ZHU	TE Connectivity NAME DYNAMIC D1100 SERIES HDR ASSY, V-TYPE, PRE-TIN 22~40POS	
DIMENSIONS: mm		CHK 03DEC2020 RICK, BIAN		
MATERIAL TBD		PRODUCT SPEC 108-78298 108-137366 APPLICATION SPEC 114-5377 WEIGHT -		RESTRICTED TO -
FINISH -		SIZE A3 CAGE CODE 00779 DRAWING NO C=1871315		SCALE 2:1
TO TOLERANCES UNLESS OTHERWISE SPECIFIED: 0 PLC ±0.13 1 PLC ±0.5 2 PLC ±0.13 3 PEC ±0.013 4 PLC ±0.0001 ANGLES ±		CUSTOMER DRAWING		SHEET 3 OF 3 REV D1

printed on 3 Feb 2021 16:39 (China Standard Time) from TE304429