

High speed digital input current limiter with digital filter

Datasheet - production data

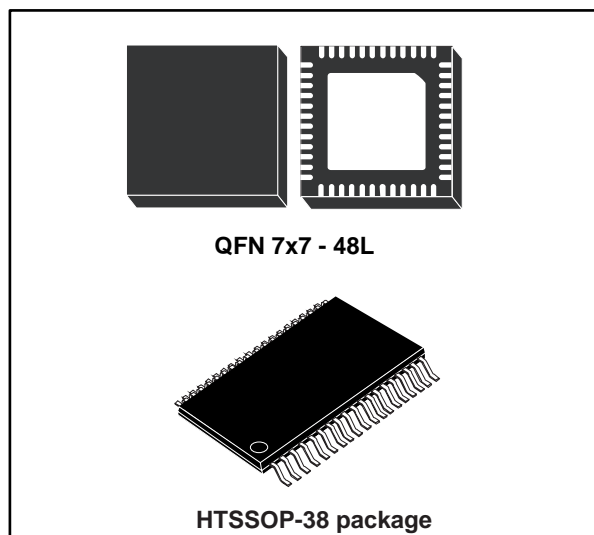

Applications

- Programmable logic controller and remote input modules
- High speed protected termination for digital input with serialized SPI output
- IEC61131-2 type 1, 2 and 3

Description

The SCLT3 series provides an 8-line protected digital input termination with serialized state transfer.

This device enhances the I/O module density by cutting the dissipation (78 mW per input) and reducing the count of opto-transistors.

An adjustable digital filter and an LED driver are embedded in each type 3 input section. Its 2 MHz SPI peripheral output serializes the input state transfer to the I/O module controller.

Features

- 8 inputs - 8-bit SPI output
- High side input with common ground
- 5 V voltage regulator
- Package: QFN 7x7 - 48L or HTSSOP-38
- 35 V reverse polarity capable
- Adjustable current limiters
- LED output for visual status
- Optional: 16-bit mode with parity check, temperature and voltage alarms
- Daisy chain capable
- Input digital filter with adjustable delay: 20 μ s to 3 ms
- Power dissipation: 78 mW per channel

Complies with the following standards

- IEC 61000-4-2
 - ± 8 kV contact discharge
 - ± 15 kV air discharge
- IEC 61000-4-4
 - Input: ± 1 kV
 - Power supply: ± 2.5 kV

Figure 1: QFN 7x7-48L (top view)

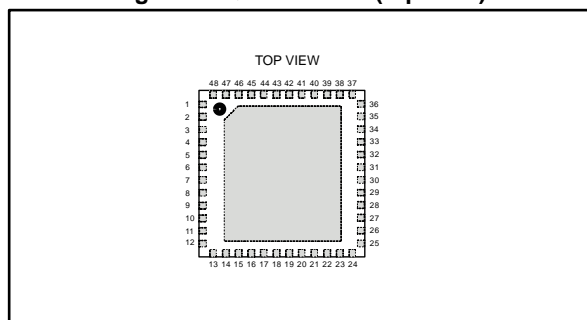

1.1 I/O pin description

Table 1: I/O pin description

Symbol		Parameter	Pin # SCLT3-8BQ7	Pin # SCLT3-8BT8
IN _I	Power input	Logic input with current limitation, I = 1 to 8	16, 17, 18, 19, 21, 22, 23, 24	8 to 11, 13 to 16
LD _I	Power output	LED output driver with current regulation, I = 1 to 8	34, 35, 36, 37, 38, 39, 40, 41	20 to 27
V _C	Power input	24 V sensor powersupply	13	5
V _{CS}	Signal input	24 V sensor power supply sensing input	14	6
COM _P	Ground	Power ground of power sensor supply	7, 15, 20, 31	4, 7, 12, 17
V _{DD}	Power output	5 V logic power supply	1	38
COM _S	Ground	Signal ground of logic / output section	43	30
REF	Signal input	Input current limiter reference setting	42	29
SPM	Signal input	SPI shift register length selector: <ul style="list-style-type: none"> • SPM to GND = 16 bits • SPM to V_{DD} = 8 bits 	4	3
/CS	Logic input	SPI chip Select signal	48	35
SCK	Logic input	SPI serial clock signal	47	34
MOSI	Logic input	SPI serial data input signal	46	33
DVR	Logic input	Divider ratio selector of the digital input filters (8 or 64 steps)	2	1
OSC	Signal input	Delay setting of the digital input filters	3	2
MISO	Logic output	SPI serial data output signal	44	31
/MISO	Logic output	Inverting SPI serial data output signal	45	32
TAB	Substrate	Exposed pad: connected to die substrate, to be connected to COM _P	TAB	Expose pad
NC		Not connected (or to be connected to COM _P)	5, 6, 8, 9, 10, 11, 12, 25, 26, 27, 28, 29, 30, 32, 33	18, 19, 28, 36, 37

Figure 4: Pinout description of the QFN 7x7-48L and HTSSOP-38 versions (top view)

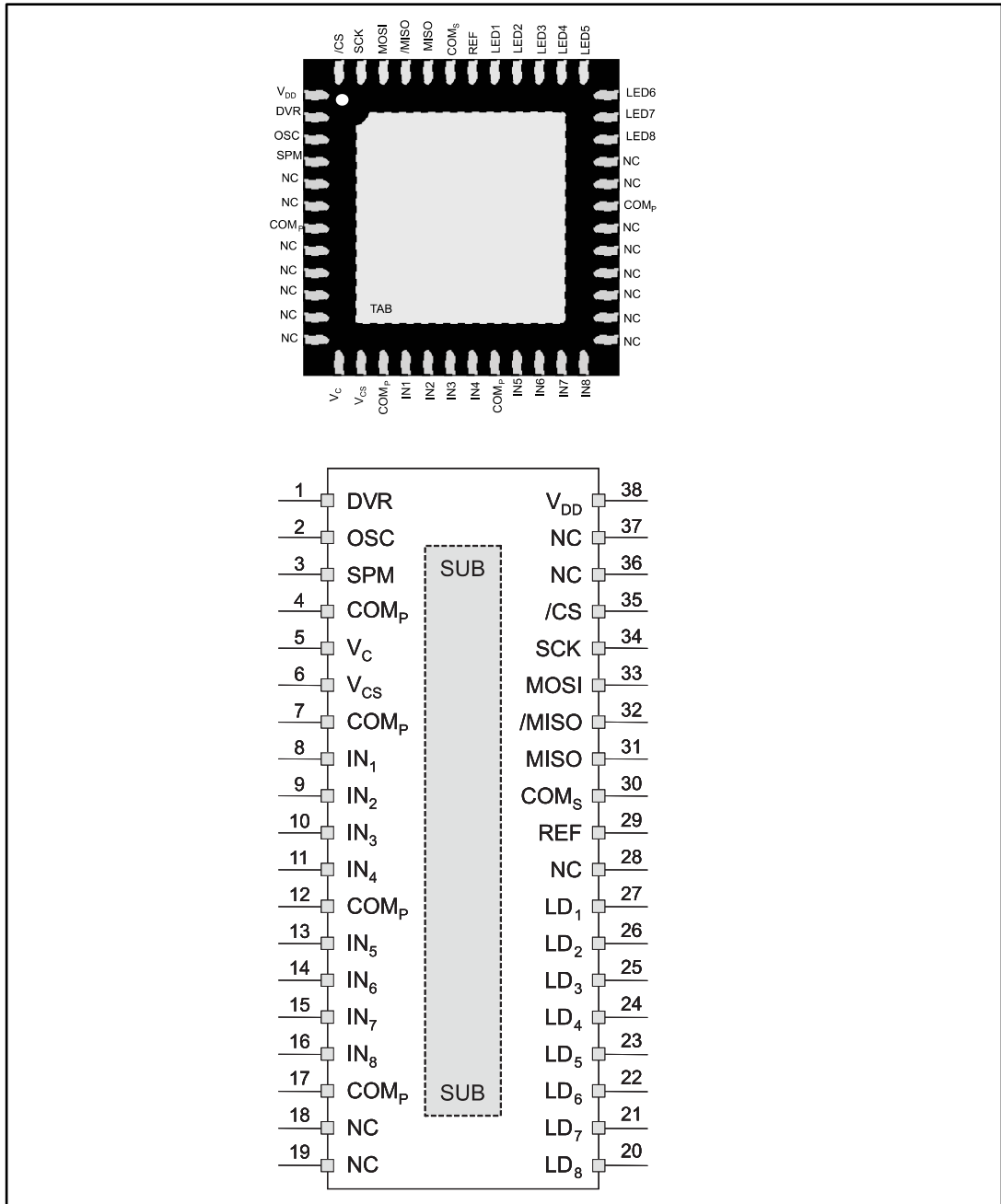
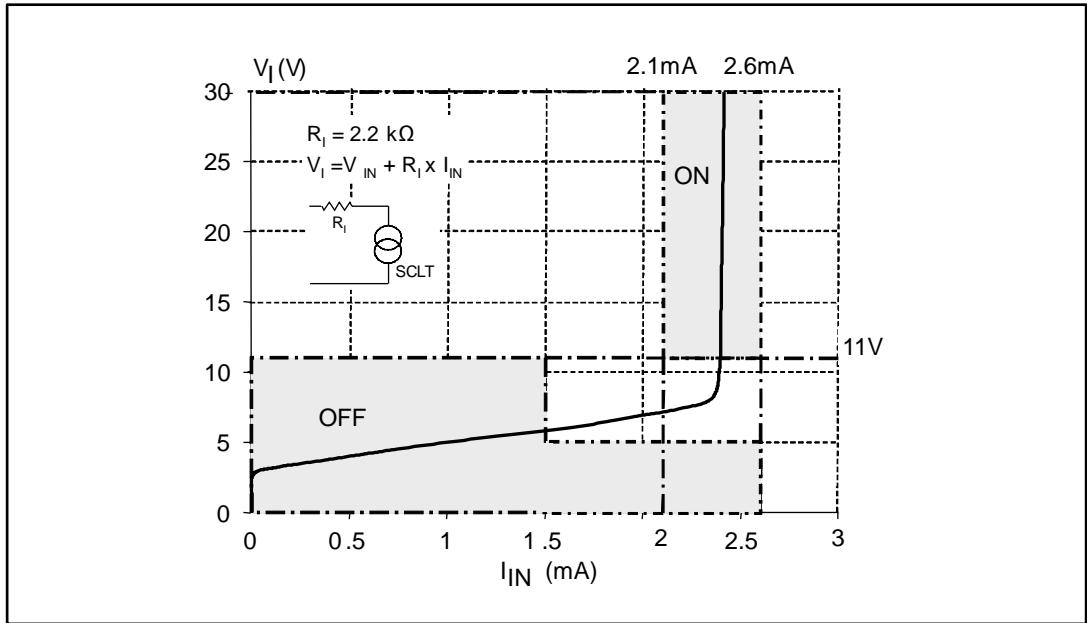

Figure 5: Basic module input characteristics in type 3



2 Characteristics

Table 2: Absolute maximum ratings

Symbol	Pin	Parameter name	Conditions	Value	Unit
V _{CC}	V _C	Bus power supply DC voltage	500 Ω < R _C < 2.2 kΩ	-35 ⁽¹⁾ to 35 ⁽²⁾	V
V _C	V _C	Power supply voltage	R _C = 0 kΩ	-0.3 to 30	V
I _{CC}	V _C	Maximum bus power supply current		15	mA
V _{CS}	V _{CS}	Sensing bus power supply voltage		-0.3 to 6	V
I _{DD}	V _{DD}	Maximum output power supply current	R _C = 500 Ω	12	mA
V _I	IN _i	Input steady state voltage, I = 1 to 8	R _I = 2.2 kΩ	-35 to 35	V
I _{IN}	IN _i	Input forward current range		-20 to 10	mA
I _{osc}	OSC	Maximum sourced oscillator current		120	μA
LV _I	SCK /CS MOSI	Logic input voltage		-0.3 to 6	V
T _{stg}		Storage temperature range		-40 to 150	°C
T _j		Ambient temperature range		-40 to 105	°C

Notes:

⁽¹⁾A reverse polarization diode must be placed on V_{CC} in order to avoid leakage when -35 V is applied

⁽²⁾70 mm² of 35 μm thick copper is required for single layer FR4 PCB to have a low enough R_{th} and therefore keep SCLT3 device below its T_{j(max)}

Table 3: Operating conditions

Symbol	Pin	Parameter name	Conditions	Value	Unit
V _{CC}	V _C	Bus power supply DC voltage	R _C > 500 Ω	15 to 35 ⁽¹⁾	V
V _{DD}	V _{DD}	Internal logic power supply voltage		5	V
I _{DD}	V _{DD}	Internal logic power supply voltage	R _C > 500 Ω	10	mA
V _I	IN	Input repetitive steady state voltage	R _I = 2.2 kΩ ⁽²⁾	-30 to 35	V
V _{LD}	LD _I	Maximum LED output voltage, I = 1 to 8		2.7	V
F _{INmax}	IN	Maximum single input frequency	8-bit mode	20	kHz
F _{SCKmax}		Maximum SPI clock frequency		0.1 to 2	MHz
R _{OSC}	OSC	Filter oscillator resistance range		15 k to 1.5 M	Ω
LV	SCK /CS MOSI MISO /MISO	Logic input / output voltage		0 to 5.5	V
T _{amb}	All	Operating ambient temperature range	V _{CC} ≤ 30 V	-40 to 85	°C
			V _{CC} ≤ 24 V R _{th(j-a)} = 70 °C/W	-40 to 105	
T _j		Operating junction temperature range		-40 to 150	°C

Notes:⁽¹⁾32 V in DC; 35 V during 0.5 s max⁽²⁾V_I = V_{IN} + R_I × I_{IN}

Table 4: DC electrical characteristics based on figure 2 application environment

Symbol	Pin	Name	Conditions	Min.	Typ.	Max.	Unit
Input current limitation							
I _{LIM}	IN	V _{IN} = 5.5 to 26 V, R _I = 2.2 kΩ		2.1	2.35	2.6	mA
I _{ON}	LD _I	On state LED current	V _I = 11 V	2			mA
Input digital filter							
T _{OSC}	OSC	Oscillator period	R _{OSC} = 51 kΩ	1.13		1.37	μs
			R _{OSC} = 1200 kΩ	20		28	μs
R _{OSC}	OSC	Oscillator resistance		51		1200	kΩ
t _{CKF}		CKF period	DVR = V _{DD}	64 × T _{OSC}			
			DVR = COM _S	8 × T _{OSC}			
t _{FT}	IN	Filtering time		2 × t _{CKF}		3 × t _{CKF}	

Table 5: SPI electrical characteristics ($T_j = 25\text{ }^\circ\text{C}$, $V_{CC} = 24\text{ V}$, $V_{DD} = 5\text{ V}$ respect to COM ground pin; unless otherwise specified)

Symbol	Pin	Name	Conditions	Min.	Typ.	Max.	Unit
F_{CK}	SCK	Clock frequency				2	MHz
T_S	MOSI	Data setup time	MOSI toggling to SCK rising	25			ns
T_D	MISO	Write out propagation time	SCK falling to MISO toggling, $C_{OUT} = 10\text{ pF}$			50	ns
T_{LD}	SCK	Enable lead time	/CK falling to SCK rising	80			ns
T_{HC}	SCK	Clock hold time	SCK falling to /CS rising	160			ns
T_{DT}	/CS	Transfer delay time	/CS rising to /CS falling			150	ns
T_H	MOSI	Data hold time	SCK rising to MOSI toggling	25			ns
T_{DIS}	MISO	Data output disable time	/CS rising to MISO disabled			200	ns
V_{IH}	MOSI, SCK, /CS	Logic input high voltage	Share of V_{DD}			70	%
V_{IL}		Logic input low voltage	Share of V_{DD}	30			%
V_{OH}	MISO, /MISO	Logic output high voltage	$I_{OH} = 3\text{ mA}$	4	4.75		V
V_{OL}		Logic output low voltage	$I_{OL} = 3\text{ mA}$		0.25	1	V
T_{RO} , T_{FO}	MISO, /MISO	MISO signal fall/rise time	$I_{MISO} = 3\text{ mA}$		20		ns
T_A	MISO	Output access time	/CS falling to MISO toggling		40	80	ns
$DuCy$	SCK	Clock duty cycle		25		75	%

Figure 6: Time diagram

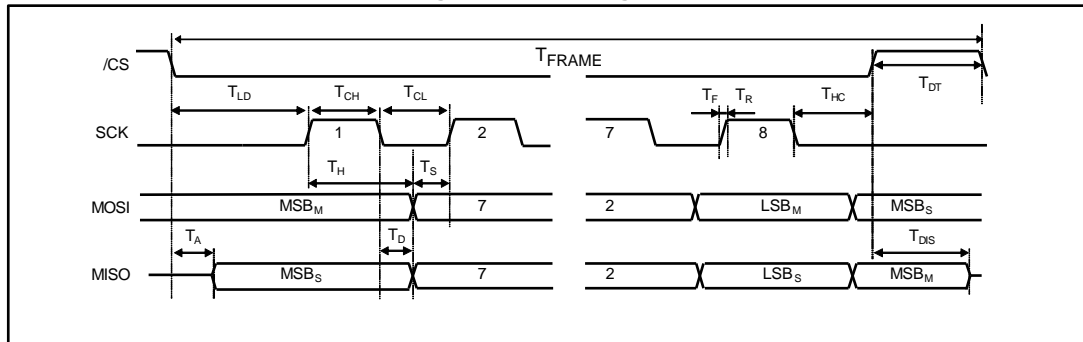

Table 6: Electromagnetic compatibility ratings

Symbol	Pin	Parameter name ⁽¹⁾	Value	Unit
V _{PPB}	V _I	Peak pulse voltage burst, IEC61000-4-4 ⁽²⁾	4	kV
V _{PP}	V _I	Peak pulse voltage surge, IEC61000-4-5	1	kV
V _{PP}	V _{CC}	Peak pulse voltage surge, IEC61000-4-5	2.5	kV
V _{ESD}	V _{IN}	ESD protection, IEC 61000-4-2, per input: Air Contact	15 8	kV

Notes:

⁽¹⁾ Test set-up, see application

⁽²⁾ See [AN3031](#).

3 Functional description

3.1 Operation of the SCLT3 with SPI bus (C_{POL} = 0, C_{PHA} = 0)

The SPI bus master controller manages the data transfer with the chip select signal /CS and controls the data shift in the register with the clock SCK signal.

Figure 7: Serial data format frame

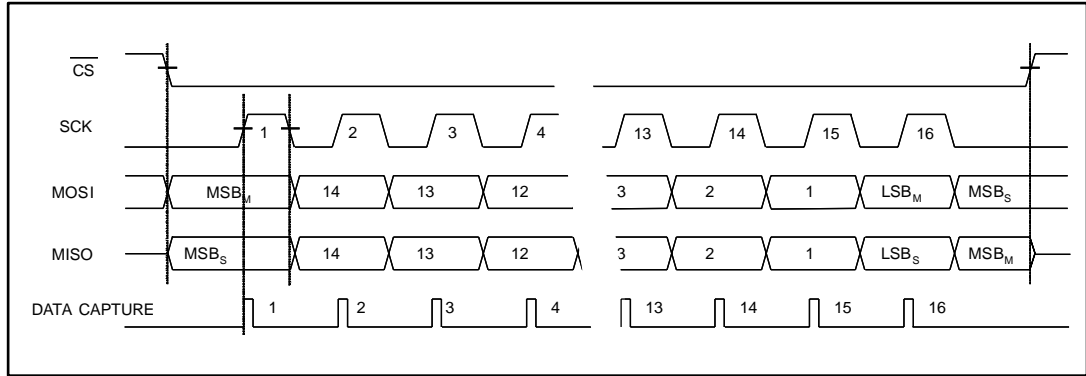

The transfer of the SCLT3 input states in the SPI registers starts when the chip select /CS signal falls and ends when this /CS is rising back.

The transfer of data out of the SCLT3 slave MISO output starts immediately when the chip select /CS goes low.

Then, the input MOSI is captured and presented to the shift register on each rising edge of the clock SCK. And the data are shifted in this register on each falling edge of the serial clock SCK, the data bits being written on the output MISO with the most significant bit first.

3.1.1 The serial data Input MOSI

This input signal MOSI is used to shift external data bits into the SCLT3 register from the most significant MSB bit to the lower significant one LSB. The data bits are captured by the SCLT3 on the rising edge of the serial clock signal SCK.

3.2 The input digital filter

Depending on the biasing of the SPM pin, the data frame is 8-bits or 16-bits.

A digital filter is implemented between the input state comparator and the input state register. It consists of a 2-step sampling circuit that is controlled by an oscillator as shown on Figure 7.

The filtering time t_{FT} is set by the external oscillator resistor and is a function of the oscillator period t_{CKF} :

- $2 \times t_{CKF} < t_{FT} < 3 \times t_{CKF}$
- $t_{CKF} = \text{Divider ratio} \times t_{OSC} (R_{OSC})$

This period can be adjusted between 20 μs and 3000 μs as shown on [Table 6: "Electromagnetic compatibility ratings"](#).

Table 7: Typical setting of the digital filter timings

Input speed	Fast		Medium	Slow
Input frequency (kHz)	60	20	5	0.3
Min. filter time t_{FT} (μ s)	20	50	230	3000
OSC resistance (k Ω)	51	150	82	1300
CKF period t_{CKF} (μ s)	10	25	115	1500
DVR connection	COM _S	COM _S	V _{DD}	V _{DD}
Divider ratio	8	8	64	64

Being placed in the front end of the module, this filter increases the transient immunity of the SCLT and its SPI logic circuitry. It also simplifies the input management software task of the ASIC controller.

Figure 8: Two step digital filter placed after the analog section of the logic input

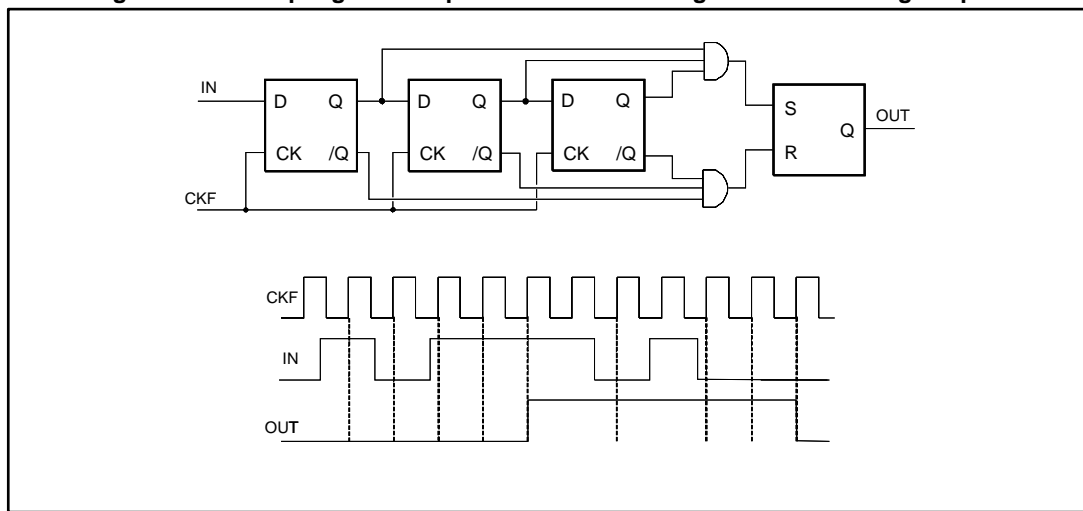

3.3 The SPI data transfer operation

3.3.1 The SPI data frame

Depending on the biasing of the SPM pin, the data frame is 8-bits or 16-bits. The selected structure of the SPI is a 16-bit word in order to be able to implement the input state data and some control bits such as the UVA alarm, the 4 checksum bits and the two low and high state stop bits.

3.3.2 The SPI data transfer

The SCLT3 transfers its 16 data bits through the SPI within one chip select Hi-Lo-Hi sequence. So, this length defines the minimum length that the shift register of the SPI master controller is able to capture: 16 bits.

The Table 8 shows the 16-bit mode way the data are transferred starting from the data bits, the control bits and ending by a stop bit.

Table 8: SPI data transfer organization versus CLT input states with SPM = 0

Bit #	LSB	Bit 1	Bit 2	Bit 3	Bit 4	Bit 5	Bit 6	Bit 7
Control	High ⁽¹⁾	Low	PC4	PC3	PC2	PC1	/OTA	/UVA
Bit #	Bit 8	Bit 9	Bit 10	Bit 11	Bit 12	Bit 13	Bit 14	MSB
Data	IN 1	IN 2	IN 3	IN 4	IN 5	IN 6	IN 7	IN 8 ⁽²⁾

Notes:

⁽¹⁾Last OUT

⁽²⁾First OUT

3.4 Control bit signals of the SPI transferred data frame

3.4.1 The power bus voltage monitoring

The UVA circuit generates the alarm /UVA that is active low when the power bus voltage is lower than the activation threshold V_{CON} , 17 V typical, and it is disabled high when the power bus voltage rises above the threshold V_{COFF} , 18 V typical.

3.4.2 The over temperature alarm

The alarm signal /OTA is enabled, low state active, when the junction temperature is higher than the activation threshold T_{ON} , 150 °C typical, and it is disabled when the junction temperature falls below the threshold T_{OFF} , 140 °C typical.

3.4.3 The parity checksum bits calculation and transfer

The aim of the parity checksum bit is to detect one error in the transferred SPI word. Several parity checksum bits are generated and transmitted through the SPI on the control bit #2 to #5. In order to calculate parity bit, “exclusive NOR” operations are performed as follow:

Figure 9: SCLT3 parity bit calculation example

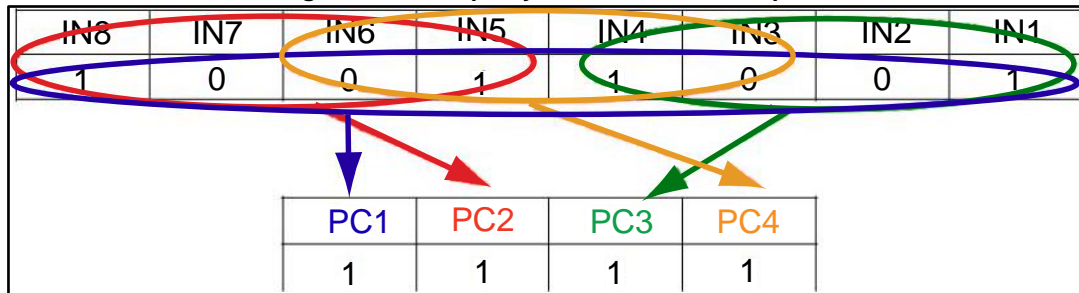

3.5 Loss of VCC power supply

The operation of the SCLT3 is extended below the levels required in the IEC 61131-2 standard to allow the implementation of the under voltage alarm UVA as described the SPI control bit section.

If there is no more power feeding on the V_{CC} input, the SCLT3 chip goes to sleep mode, and the MISO output is forced in low state during SPI transfer attempt. The last SPI control data bit is a stop bit placed normally in high state all time: the loss of power supply is detected by checking its state: if low, the output is disabled by the internal power reset POR.

This POR signal is active in low state when VC is less than 9 V or the internal power supply V_{DD} is less than 3.25 V.

Table 9: Logic state of the SPI output versus the power loss signal POR and the SPI chip select /CS

POR	/CS	MISO	/MISO	SPI status
1	1	Z	Z	Normal with no communication
1	0	1	0	Normal with communication
1	0	0	1	Normal with communication
0	1	Z	Z	Power loss with no communication
0	0	0	1	Power loss with communication attempt

Figure 10: Logic status of the SCLT3 power supply

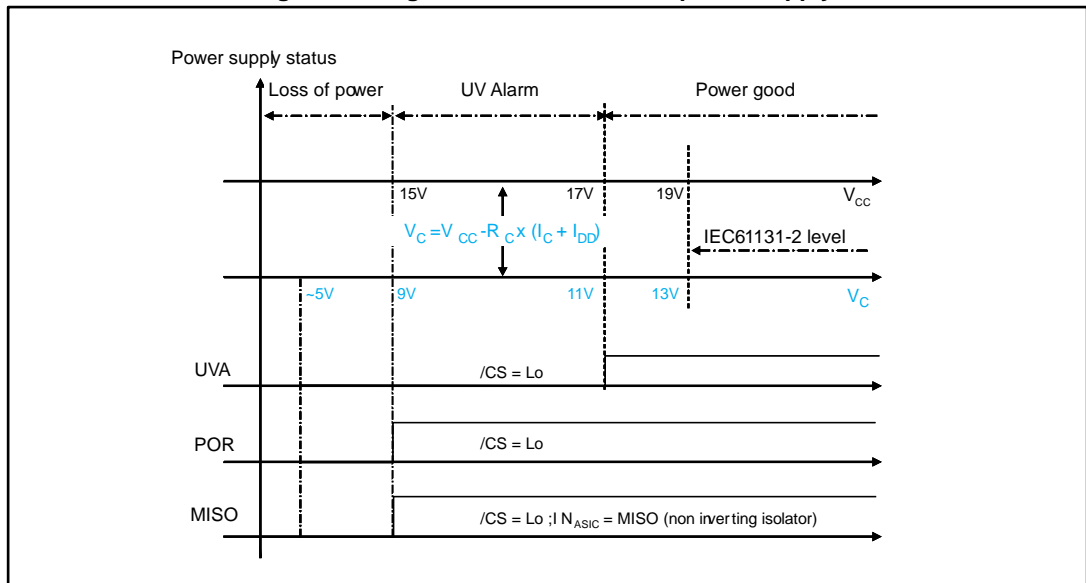

Figure 11: Typical limiting current I_{LIM} versus reference resistance R_{REF}

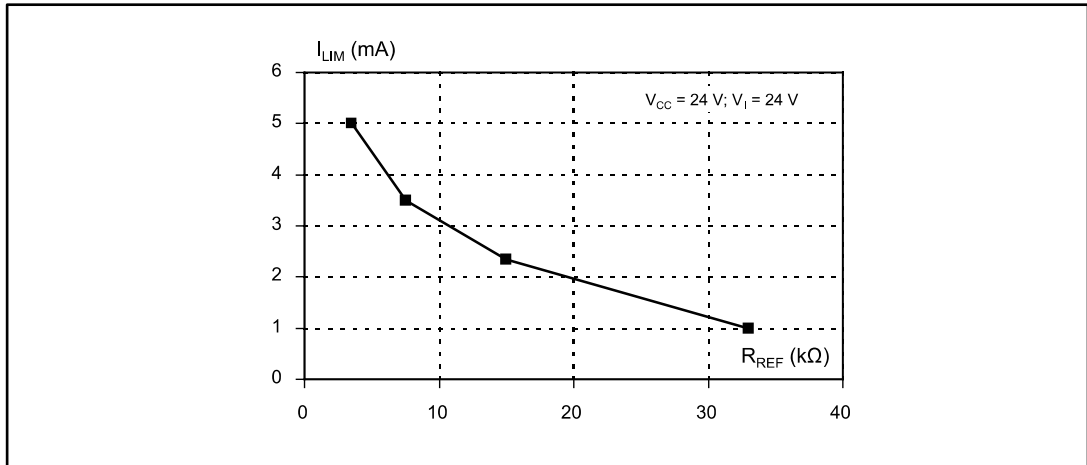

Figure 12: Typical limiting current I_{LIM} versus junction temperature T_J

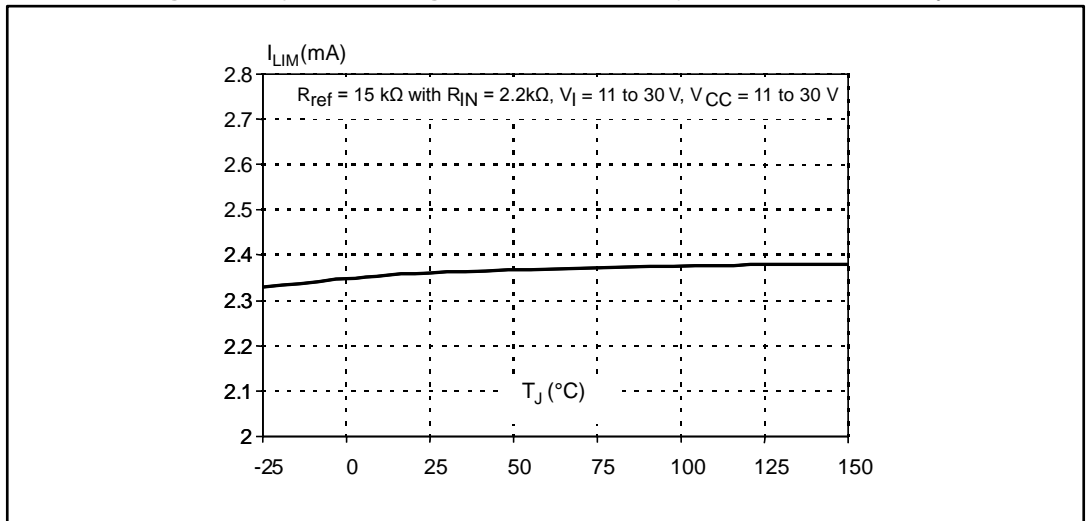

Figure 13: Relative variation of minimum filter time t_{FT} versus junction temperature T_J

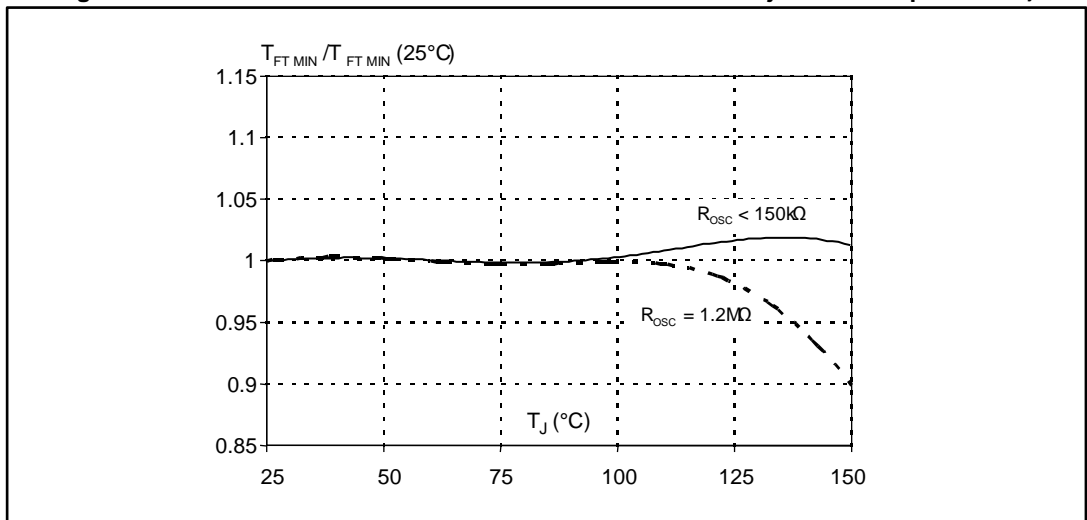
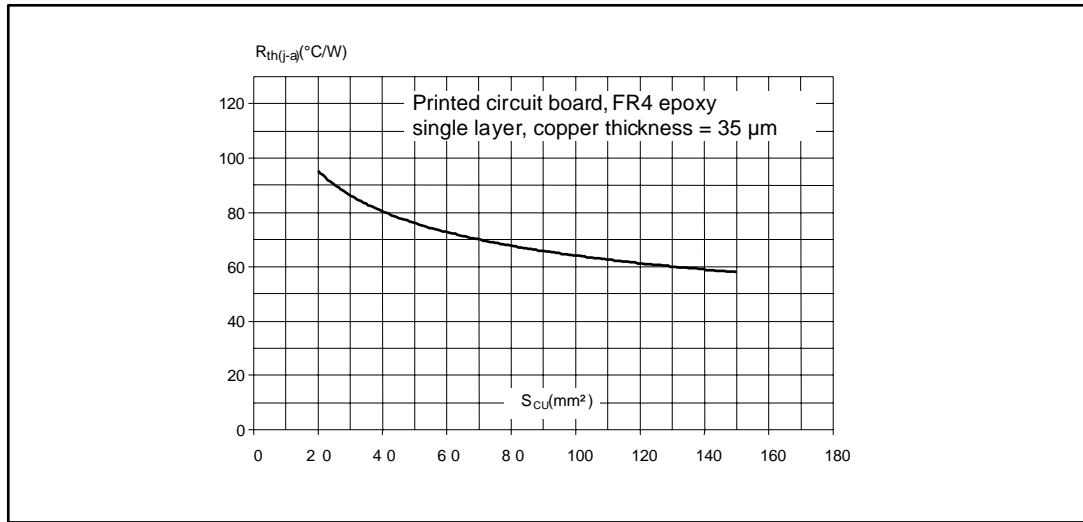

Figure 14: Variation of junction to ambient thermal resistance $R_{th(j-a)}$ versus printed circuit board copper surface S_{Cu}



4 Package information

In order to meet environmental requirements, ST offers these devices in different grades of ECOPACK® packages, depending on their level of environmental compliance. ECOPACK® specifications, grade definitions and product status are available at: www.st.com. ECOPACK® is an ST trademark.

4.1 QFN 7X7-48 L package information

Figure 15: QFN 7X7-48 L package outline

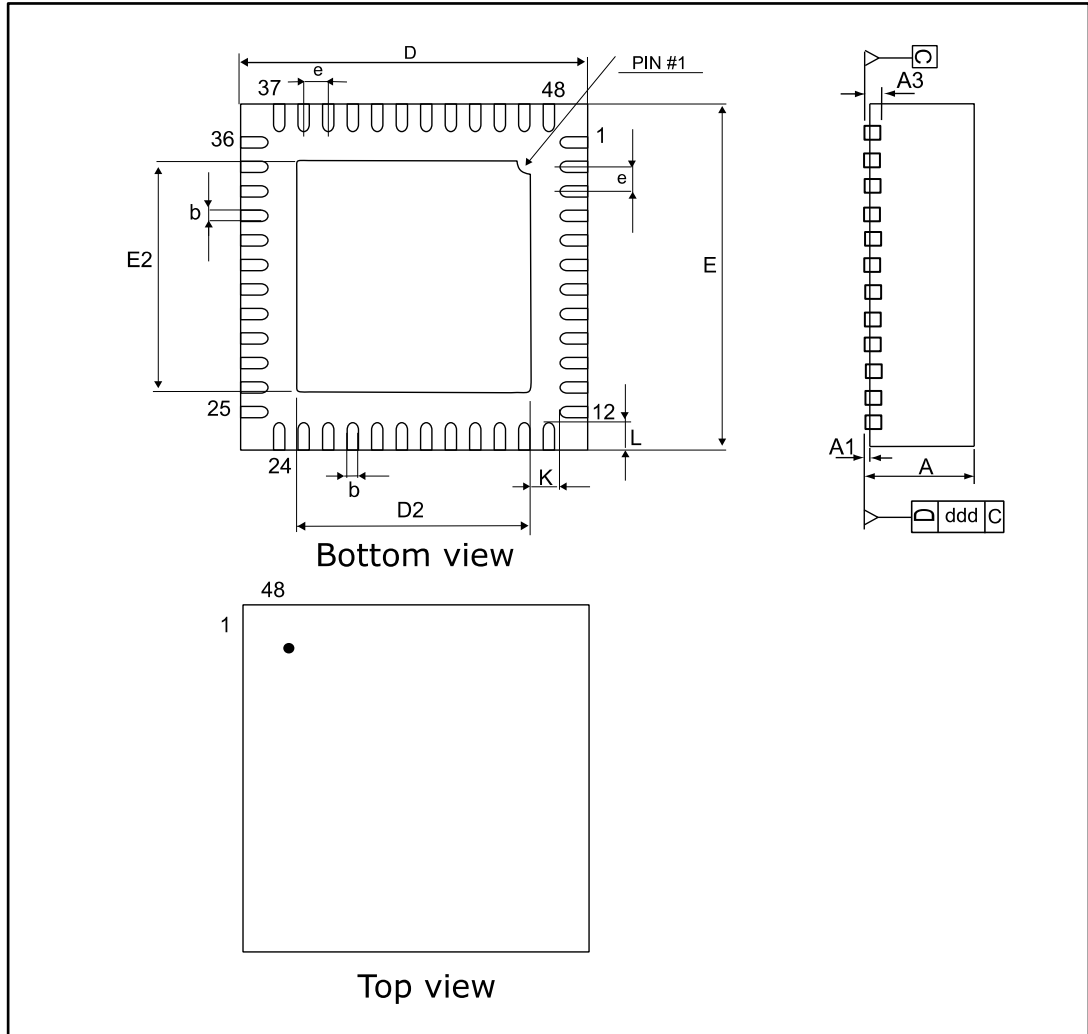

Table 10: QFN 7X7-48 L package mechanical data

Ref.	Dimensions					
	Millimeters			Inches ⁽¹⁾		
	Min.	Typ.	Max.	Min.	Typ.	Max.
A	0.80	0.90	1.00	0.0315	0.0354	0.0394
A1		0.02	0.05		0.0008	0.0020
A3		0.203			0.008	
b	0.18	0.25	0.30	0.0071	0.0100	0.0118
D		7.00			0.275	
E		7.00			0.275	
e		0.50			0.019	
D2	5.00	5.15	5.25	0.197	0.203	0.206
E2	5.00	5.15	5.25	0.197	0.203	0.206
K	0.20			0.008		
L	0.30	0.40	0.50	0.011	0.015	0.019

Notes:

⁽¹⁾Values in inches are converted from mm and rounded to 4 decimal digits.

4.2 HTSSOP-38 package information

Figure 16: HTSSOP-38 package outline

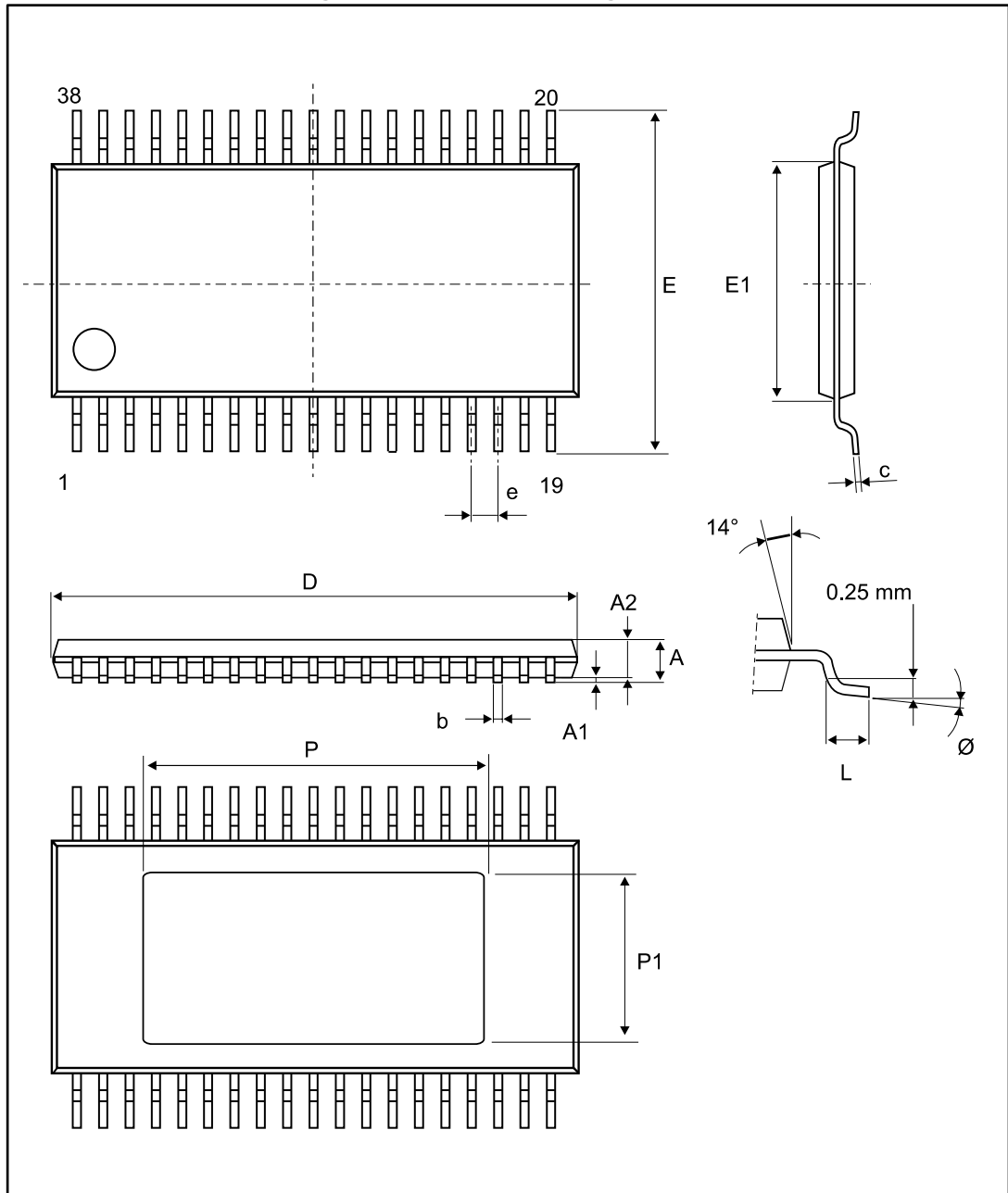
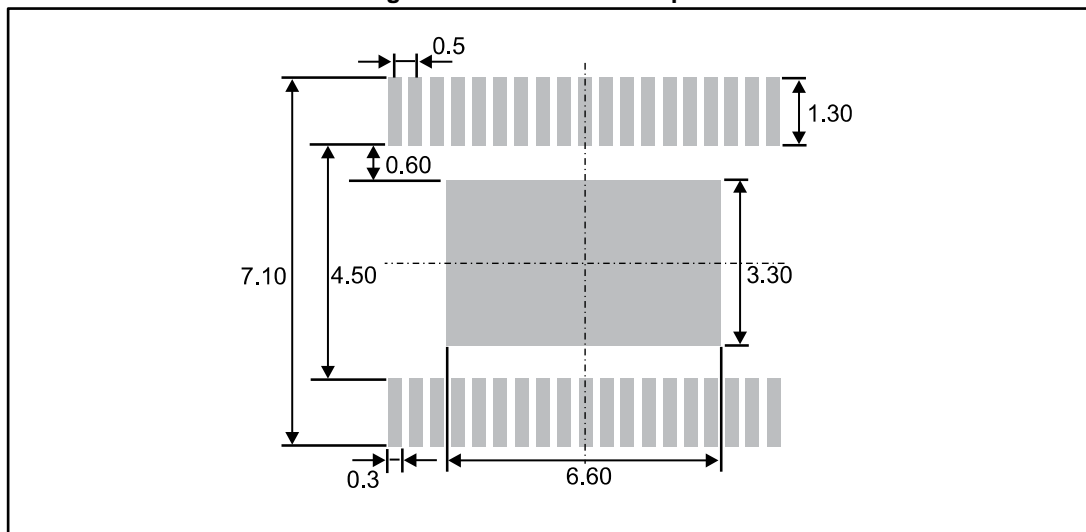

Table 11: HTSSOP-38 package mechanical data

Ref.	Dimensions					
	Millimeters			Inches		
	Min.	Typ.	Max.	Min.	Typ.	Max.
A			1.10			0.043
A1	0.05		0.15	0.002		0.006
A2	0.85	0.90	0.95	0.033	0.035	0.037
b	0.17		0.27	0.007		0.011
c	0.09		0.20	0.003		0.008
D	9.60	9.70	9.80	0.378	0.382	0.386
E1	4.30	4.40	4.50	0.169	0.173	0.177
e		0.50			0.020	
E		6.40			0.252	
L	0.50	0.60	0.70	0.020	0.024	0.027
P	6.40	6.50	6.60	0.252	0.256	0.260
P1	3.10	3.20	3.30	0.122	0.126	0.130
∅	0°		8°	0°		8°

Figure 17: HTSSOP-38 footprint



5 Ordering information

Figure 18: Ordering information scheme

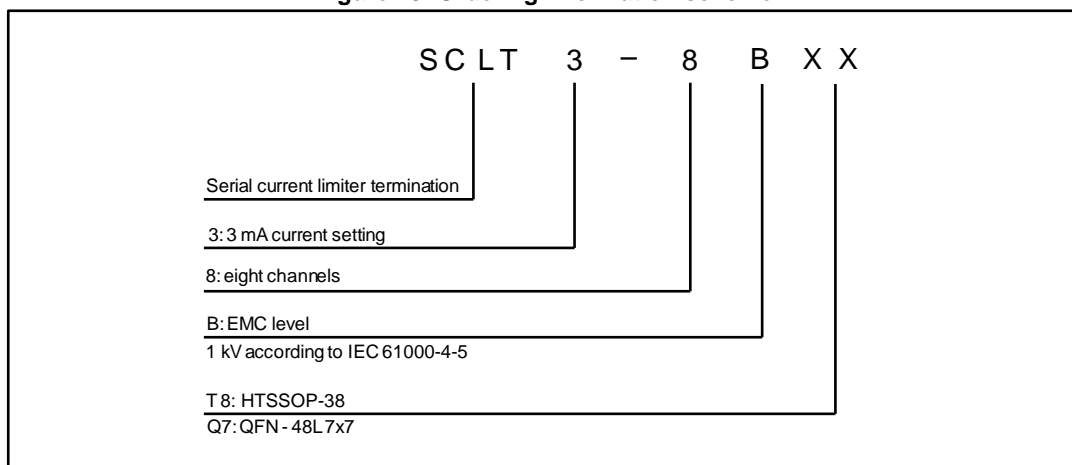

Table 12: Ordering information

Order code	Marking	Package	Weight	Base qty.	Delivery mode
SCLT3-8BT8-TR	SCLT3-8BT8	HTSSOP-38	114 mg	2500	Tape and reel
SCLT3-8BQ7-TR	SCLT3-8BQ7	QFN7x7-48L	130 mg	2500	Tape and reel

6 Revision history

Table 13: Document revision history

Date	Revision	Changes
29-Jul-2016	1	Initial release.
12-Nov-2015	2	Updated <i>Table 4</i> .
05-Dec-2016	3	Added part number previously included in the datasheet DocID15191. Updated document accordingly. Minor text changes.

IMPORTANT NOTICE – PLEASE READ CAREFULLY

STMicroelectronics NV and its subsidiaries ("ST") reserve the right to make changes, corrections, enhancements, modifications, and improvements to ST products and/or to this document at any time without notice. Purchasers should obtain the latest relevant information on ST products before placing orders. ST products are sold pursuant to ST's terms and conditions of sale in place at the time of order acknowledgement.

Purchasers are solely responsible for the choice, selection, and use of ST products and ST assumes no liability for application assistance or the design of Purchasers' products.

No license, express or implied, to any intellectual property right is granted by ST herein.

Resale of ST products with provisions different from the information set forth herein shall void any warranty granted by ST for such product.

ST and the ST logo are trademarks of ST. All other product or service names are the property of their respective owners.

Information in this document supersedes and replaces information previously supplied in any prior versions of this document.

© 2016 STMicroelectronics – All rights reserved